



THERMOACOUSTIC INSULATION
POLYMER BITUMEN MEMBRANES
BITUMEN ROOF SHINGLES
SYNTHETIC MEMBRANES
ACCESSORY PRODUCTS
WATERPROOFING
WITH LIQUID PRODUCTS

GENERAL CATALOGUE

SOPREMA

May 2022



2022 General Catalogue Index

Rev. 02 - May



Thermal Insulation	Page 11
Acoustic Insulation	Page 43
Professional Waterproofing Membranes	Page 47
Self-Adhesive Membranes	Page 55
Waterproofing Membranes Building Line	Page 69
Bitumen Roof Shingles	Page 75
Complementary Products and Accessories	Page 79
Synthetic Membranes	Page 87
Primers, Liquid Products, Sealants, Foams and Adhesives	Page 117

Thermal and acoustic insulation and waterproofing systems and solutions for every section of the envelope





As an independent family group since 1908, SOPREMA has established itself as one of the world's leading companies in the waterproofing business and also as a specialist in roofing, acoustic panels and insulation, civil rock.

Over the years, the SOPREMA Group has grown, diversifying its business and integrating complementary activities. SOPREMA offers high-performance and sustainable products, constantly optimized by Research & Development laboratories, boasting exceptional characteristics in terms of reliability and longevity.

In SOPREMA, sustainability is an essential driver that pushes us towards the creation of a sustainable building model in 2 main points: creating energy-efficient products and adopting an analysis-oriented approach of the life cycle of our products. Our goal is to promote a vision of a responsible construction.

SOPREMA's know-how and continuous Research & Development activities, come into a wide range of products and systems capable of satisfying various construction needs.

DESIGN SOLUTIONS

READ THE SOPREMA IDEAL SYSTEMS GUIDE



THERMAL AND ACOUSTIC INSULATION



POLYMER BITUMEN MEMBRANES



WATERPROOFING WITH LIQUID PRODUCTS



SYNTHETIC MEMBRANES

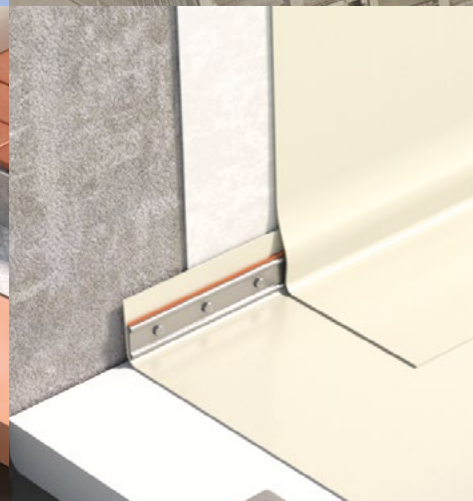
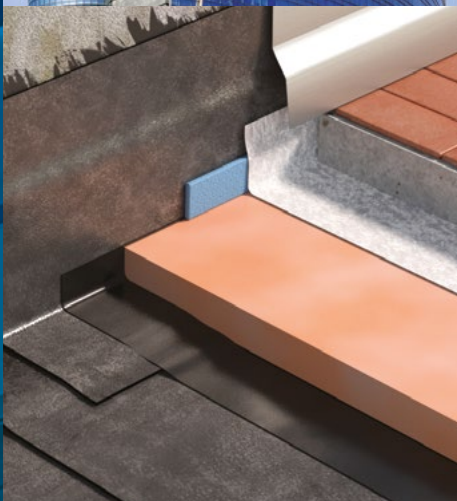
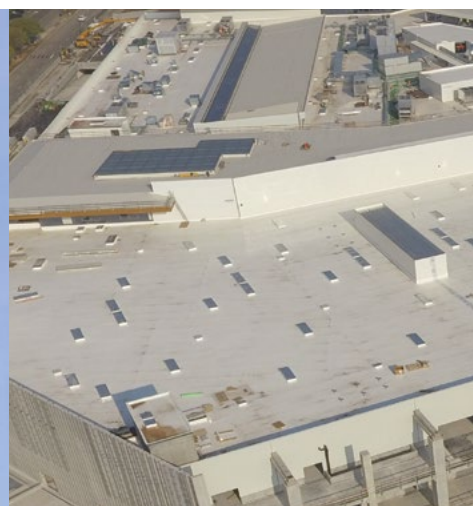

VISIBLE ROOFING ACCORDING TO SOPREMA: HIGH ENERGY EFFICIENCY & DURABILITY WITH SYNTHETIC MEMBRANE

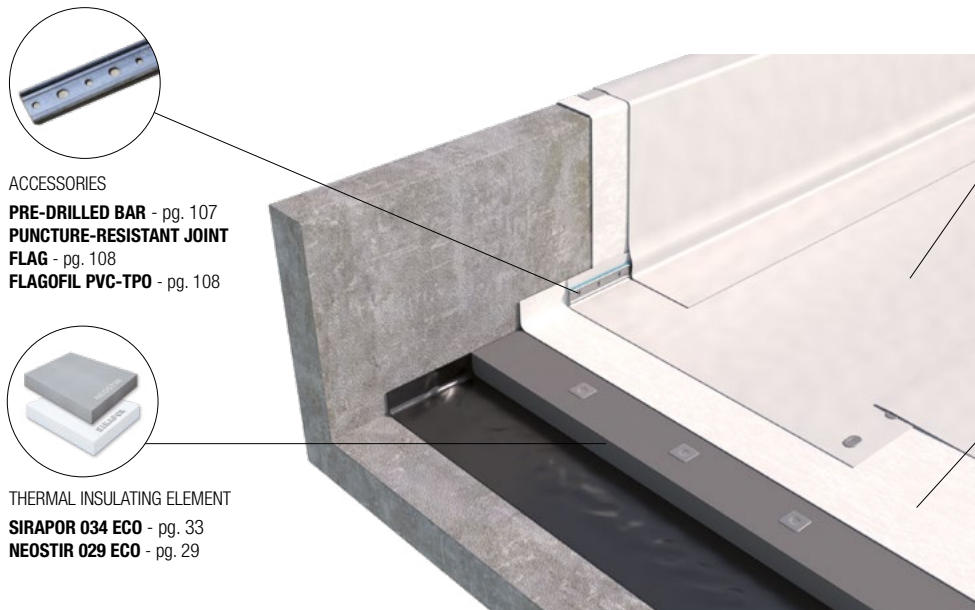

ACCESSORIES
PRE-DRILLED BAR - pg. 107
PUNCTURE-RESISTANT JOINT FLAG - pg. 108
FLAGOFIL PVC-TPO - pg. 108

THERMAL INSULATING ELEMENT
SIRAPOR 034 ECO - pg. 33
NEOSTIR 029 ECO - pg. 29

SEALING ELEMENT
TPO
FLAGON EP/PR - pg. 93
FLAGON EP/PR ENERGY PLUS - pg. 95
FLAGON EP/PR-SC - pg. 96

PVC
FLAGON SR - pg. 89
FLAGON SR ENERGY PLUS - pg. 90
FLAGON SR/FR-M2 - pg. 91

SEPARATION LAYER
GEOTEXTILE FLAG PET TT (FOR PVC ONLY) - pg. 83
SOPRAVOILE 120 - pg. 106

SOPREMA'S EXPERT OPINION

The system proposed by Soprema guarantees high thermal performance with a significant reduction in heating costs. It allows the installation of any photovoltaic system and is compliant with the Minimum Environmental Criteria (CAM - Criteri Ambientali Minimi). The advantage of this solution is its versatility in ensuring both waterproofing and the Cool Roof and Roof function, depending on the selected membrane.

For the full layering, refer to the system sheets at www.soprema.it or contact the Soprema technical department: tech-office@soprema.it

		"TOP" SYSTEM	"TOP" COOL ROOF SYSTEM	"TOP" BRoof system
SOLUT. 1	TPO sealing element	FLAGON EP/PR 2 mm	FLAGON EP/PR ENERGY PLUS 2 mm	FLAGON EP/PR-SC 2 mm
SOLUT. 2	PVC sealing element	FLAGON SR 2 mm	FLAGON SR ENERGY PLUS 2 mm	FLAGON SR/FR-M2 2 mm
	Separation layer	Geotextile Flag PET TT $\geq 200 \text{ g/m}^2$ (for PVC only)		SOPRAVOILE 120
	Thermal insulating element	SIRAPOR 034 ECO - NEOSTIR 029 ECO		EFIGREEN ACIER
	Accessories	PRE-DRILLED BAR - PUNCTURE-RESISTANT JOINT - FLAGOFIL PVC-TPO		

WITH BITUMEN MEMBRANE

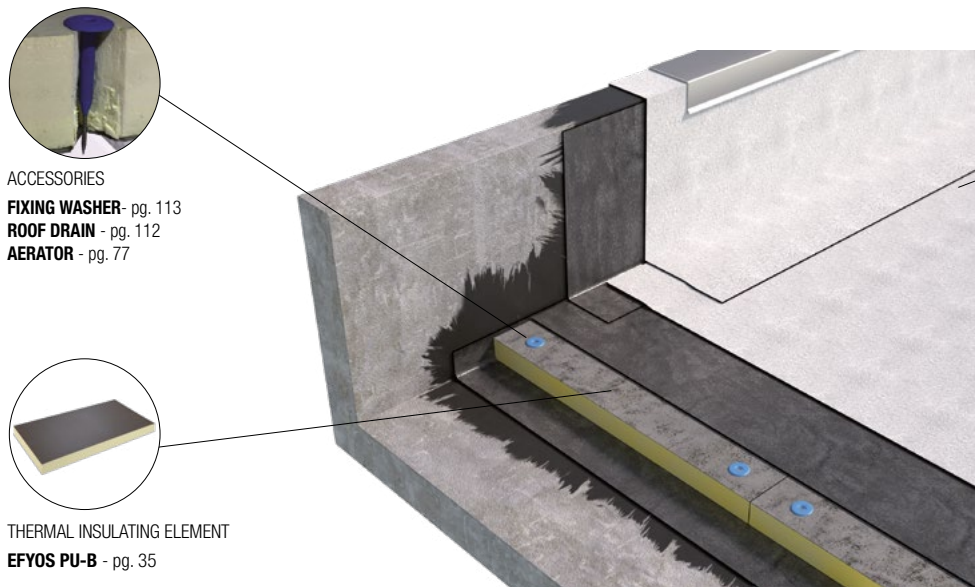

ACCESSORIES
FIXING WASHER - pg. 113
ROOF DRAIN - pg. 112
AERATOR - pg. 77

THERMAL INSULATING ELEMENT
EFYOS PU-B - pg. 35

SEALING ELEMENT
NOVATOP + EUROPOL MINERAL - pg. 51
NOVATOP + EUROSTAR REFLECTA - pg. 51 - 58
NOVATER SP FR + NOVATER SP FR-MINERAL - pg. 59

SOPREMA'S EXPERT OPINION

The proposed system guarantees the high thermal performance of the envelope with a significant reduction in heating costs and complies with the Minimum Environmental Criteria (CAM - Criteri Ambientali Minimi). Moreover, the solution limits power demands for summer cooling and urban heating.

For the full layering, refer to the system sheets at www.soprema.it or contact the Soprema Technical Department: tech-office@soprema.it

		"TOP" SYSTEM	"TOP" COOL ROOF SYSTEM	"TOP" BRoof system
Sealing element	2nd layer	EUROPOL MINERAL 4 mm (on seldedge)	EUROSTAR REFLECTA 4 mm (on seldedge)	NOVATER SP FR-MINERAL 4 mm (on seldedge)
	1st layer	NOVATOP 4 mm	NOVATOP 4 mm	NOVATER SP FR 4 mm
Thermal insulating element		EFYOS PU-B		
Accessory		FIXING WASHER - ROOF DRAIN - AERATOR		

SUSTAINABLE BUILDING RHYMES WITH GREEN ROOF: HERE ARE SOPREMA SOLUTIONS WITH SYNTHETIC MEMBRANE

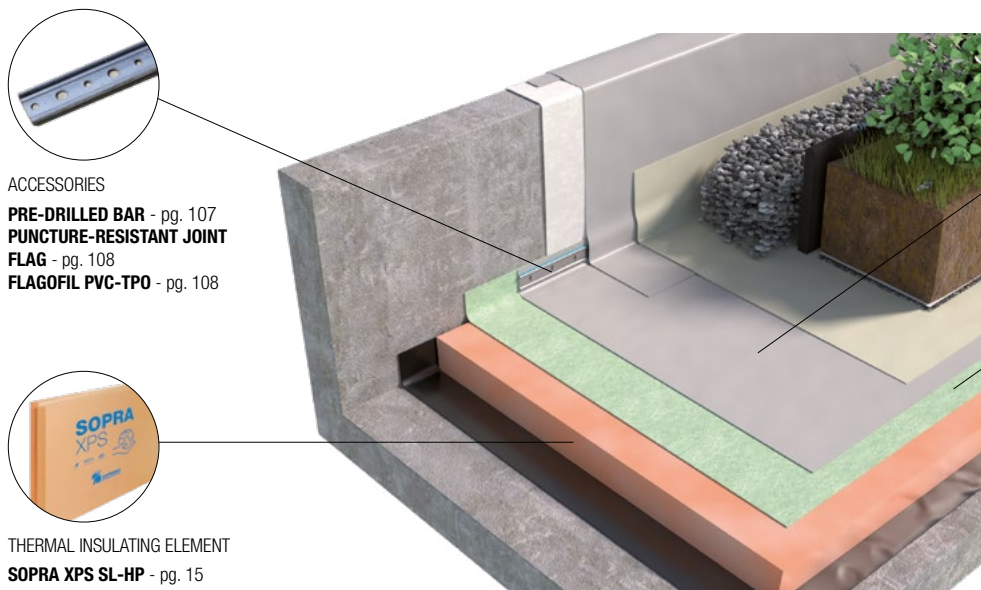

ACCESSORIES

- PRE-DRILLED BAR** - pg. 107
- PUNCTURE-RESISTANT JOINT FLAG** - pg. 108
- FLAGOFIL PVC-TPO** - pg. 108



THERMAL INSULATING ELEMENT
SOPRA XPS SL-HP - pg. 15

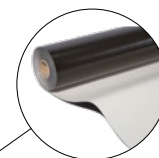

SEALING ELEMENT
TPO
FLAGON EP/PV - pg. 94
PVC
FLAGON SV - pg. 88



SEPARATION LAYER
GEOTEXTILE FLAG PET (FOR PVC ONLY) - pg. 83

SOPREMA'S EXPERT OPINION

The advantages of this technical solution are manifold, both in terms of performance and the urban and environmental impact in the context where the building is erected. In addition to energy savings through the use of insulation panels in XPS, it lowers the temperatures of the surrounding environment, reducing the effects associated with urban heat islands.

For the full layering, refer to the system sheets at www.soprema.it or contact the Soprema Technical Department: tech-office@soprema.it

SOLUTION 1
SOLUTION 2

	"TOP" SYSTEM
TPO sealing element	FLAGON EP/PV 2 mm
PVC sealing element	FLAGON SV 2 mm
Separation layer	Geotextile Flat PET ≥ 200 g/m² (for PVC only)
Thermal insulating element	SOPRA XPS SL-HP
Accessories	PRE-DRILLED BAR - PUNCTURE-RESISTANT JOINT - FLAGOFIL PVC-TPO

WITH BITUMEN MEMBRANE

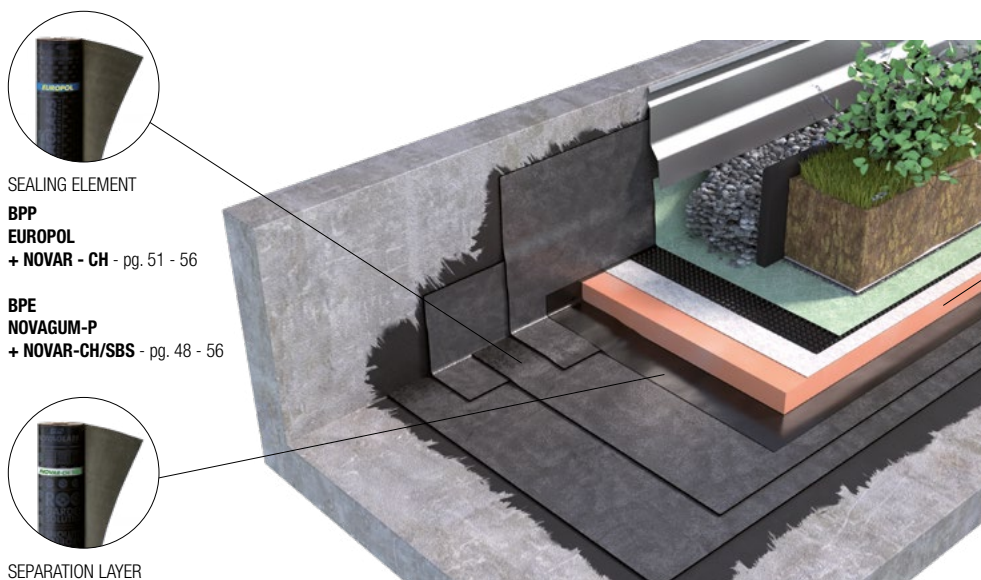

SEALING ELEMENT

BPP
EUROPOL
+ NOVAR - CH - pg. 51 - 56

BPE
NOVAGUM-P
+ NOVAR-CH/SBS - pg. 48 - 56

SEPARATION LAYER

VAPOR FLAG - pg. 84



THERMAL INSULATING ELEMENT
SOPRA XPS 500 - pg. 18
SOPRA XPS 700 - pg. 19

SOPREMA'S EXPERT OPINION

On par with the system with synthetic membrane, the system with bitumen membrane ensures the high efficiency of the envelope, mitigating thermal excursions and reducing power demands for winter heating and summer cooling. It also limits the effects of atmospheric heating thanks to the evapotranspiration of the plants.

For the full layering, refer to the system sheets at www.soprema.it or contact the Soprema technical department: tech-office@soprema.it

SOLUTION 1
SOLUTION 2

		"TOP" SYSTEM
Sealing element	2nd layer BPP	NOVAR-CH 4 mm
	1st layer BPP	EUROPOL 4 mm
Sealing element	2nd layer BPE	NOVAR-CH/SBS 4 mm
	1st layer BPE	NOVAGUM-P 4 mm
Separation layer		VAPOR FLAG
Thermal insulating element		SOPRA XPS 500 - SOPRA XPS 700
Accessories		GEOTEXTILE FLAG PET - GEOLAND HT

PITCHED ROOFING: THE SOPREMA SOLUTION FOR THE MICROVENTILATED ROOF SYSTEM

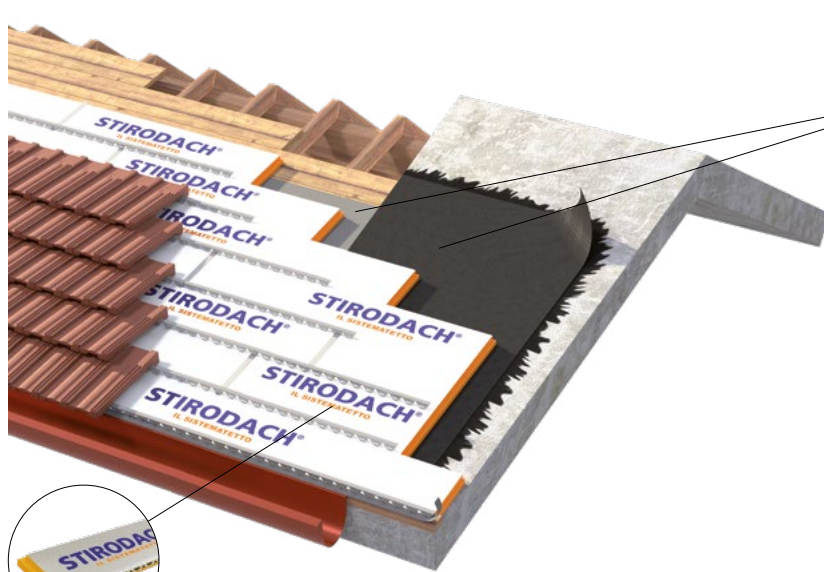

VAPOUR CONTROL LAYER
STRATEC II - pg. 106
NOVA SK ALU - pg. 55



THERMAL INSULATING ELEMENT
STIRODACH - pg. 39

For the full layering, refer to the system sheets at www.soprema.it or contact the Soprema technical department: tech-office@soprema.it

SOPREMA'S EXPERT OPINION

Stirodach is the Soprema roof-system, an ideal solution to improve the energy efficiency of pitched roofs, which guarantees high thermal insulation and microventilation. Stirodach can be used with various types of roof shingles and bent tiles, and is guaranteed to last over time. Soprema also offers an accessory kit for its installation.

	"TOP" SYSTEM
Sealing element	Cement, clay roof tiles, or bent tiles with hook
Thermal insulating element	STIRODACH
Vapour control layer	STRATEC II - NOVA SK ALU
Load-bearing element	Primary frame and wooden planking
Accessories	STIRODACH GRONDA - ALUBAND - COVERDACH ALU - ALSAN SIL 2440 FA ALSAN FOAM UNI - CV BRACKETS - CLIPS - DACHROLL - BIRD SCREENS - DOWELS

PITCHED ROOFING: THE SYSTEM WITH VENTILATED ROOF



VAPOUR CONTROL LAYER
NOVA SK ALU - pg. 55



HEAT REFLECTIVE LAYER
STRATEC II - pg. 106

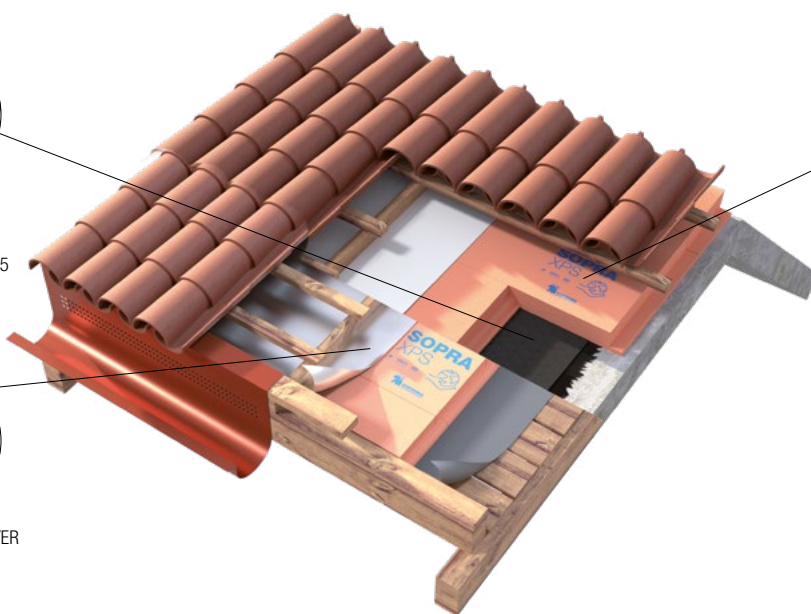

THERMAL INSULATING ELEMENT
SOPRA XPS SL-HP - pg. 15
SOPRA XPS CW - pg. 16

SOPREMA'S EXPERT OPINION

The roof is the partition of a building through which the most heat is lost, quantifiable in approximately 30%. For wooden structures, the highest performing technical solution is called "roof sarking", which allows excellent thermal insulation and efficient ventilation from the eaves to the tip, which is particularly important in the summer. The proposed XPS insulation allows high performance levels for this type of system.

For the full layering, refer to the system sheets at www.soprema.it or contact the Soprema technical department: tech-office@soprema.it

	"TOP" SYSTEM
Sealing element	Cement, clay roof tiles, or bent tiles with hook
Ventilation layer	Double wooden framework
Heat reflective layer	STRATEC II
Thermal insulating element	SOPRA XPS SL-HP - SOPRA XPS CW
Vapour control layer	NOVA SK ALU
Primer layer	ELASTOCOL 600
Load-bearing element	Concrete slab

AN EFFICIENT, STATE-OF-THE-ART EXTERNAL THERMAL INSULATION COMPOSITE SYSTEM

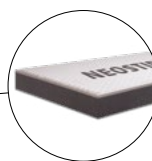
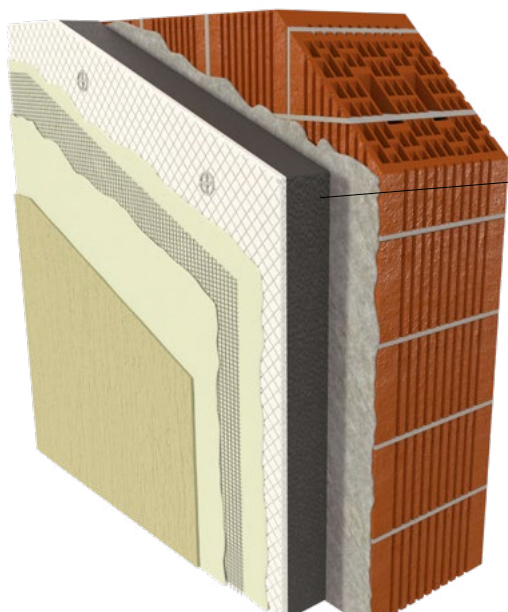

THERMAL INSULATING ELEMENT

NEOSTIR GW ECO - pg. 27
NEOSTIR EPS 100 ECO - pg. 21

SOPREMA'S EXPERT OPINION

The main advantages of the ETICS system proposed by Soprema include excellent thermal insulation, high energy savings, complete thermal and structural protection of the building and the absence of condensate even in the presence of thermal bridges. The proposed insulating products in EPS comply with the minimum environmental criteria (CAM - Criteri Ambientali Minimi) and represent the ideal solution for this type of system.

For the full layering, refer to the system sheets at www.soprema.it or contact the Soprema technical department: tech-office@soprema.it

"TOP" SYSTEM	
Surface finish	Reinforced skim coat and external plaster
Thermal insulating element	NEOSTIR GW ECO - NEOSTIR EPS 100 ECO
Masonry	Masonry in hollow brick - cement

THE INSULATION SYSTEM FOR VENTILATED PERIMETER WALLS



THERMAL INSULATING ELEMENT

SOPRA XPS SL-HP - pg. 15
SOPRA XPS CW - pg. 16

SOPREMA'S EXPERT OPINION

Even for ventilated wall systems, the proposed solution is an example of eco-sustainable technology allowing high levels of thermal insulation thanks to its low thermal conductivity. The Sopra XPS panels comply with the Minimum Environmental Criteria (CAM - Criteri Ambientali Minimi) and are recyclable at the end of the building's life.

For the full layering, refer to the system sheets at www.soprema.it or contact the Soprema technical department: tech-office@soprema.it

"TOP" SYSTEM	
External masonry	Hollow blocks, external finish
Thermal insulating element	SOPRA XPS SL-HP - SOPRA XPS CW
Internal masonry	Masonry in hollow brick - cement

WALL-TO-FLOOR JUNCTION IN CONCRETE? SOPREMA HAS THE SOLUTION WITH ALSAN FLASHING QUADRO

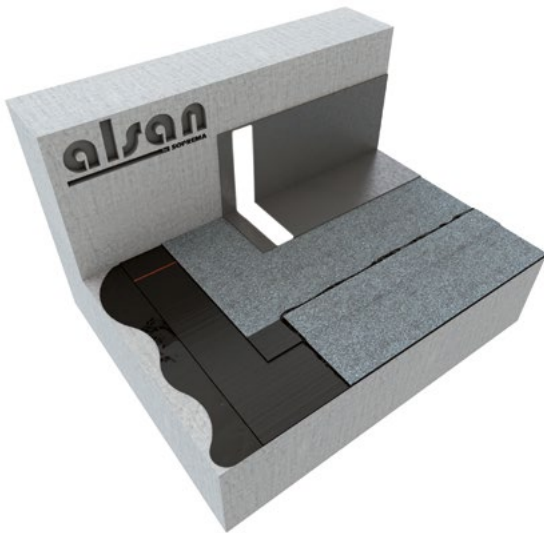

HIGH-RESISTANCE
POLYURETHANE COATING
ALSAN FLASHING QUADRO - pg. 121

For the full layering, refer to the system sheets at www.soprema.it or contact the Soprema technical department: tech-office@soprema.it

	"TOP" SYSTEM
Substrate	Concrete or Bitumen membrane
Base coat	No base coat required
High-resistance polyurethane coating	ALSAN FLASHING QUADRO

SOPREMA'S EXPERT OPINION

One of the major challenges for designers and installers is how to combine waterproofing and coating systems with other structural elements, openings and construction details. The solution to this problem is ALSAN liquid resins for junctions and turn-ups. The resins, characterised by torchless, non-destructive application, do not damage the profiles of doors and windows. Moreover, the integrated drainage is not obstructed by mechanical fasteners. ALSAN liquid resins allow the perfect and long-lasting waterproofing of all types of openings.

External reinforced WATERPROOFING BY SOPREMA



WATERPROOF POLYURETHANE
RESIN
TEXPUR - pg. 124

For the full layering, refer to the system sheets at www.soprema.it or contact the Soprema technical department: tech-office@soprema.it

	"TOP" SYSTEM
Primer	TEXPRIMER
Waterproof polyurethane resin	TEXPUR
Reinforcement fabric	ALSAN FLEECE
High-resistance polyurethane coating	TEXCAP F

SOPREMA'S EXPERT OPINION

The TEXPUR system by Soprema offers numerous advantages in terms of application and long-lasting performance. It adapts to any surface, is resistant to stagnant water, and in case of tampering with the membrane, can be repaired in just a few minutes. TEXPUR is easy to apply and also allows the possibility for a coloured finish. Lastly, its versatility makes it ideal for many fields of application.





Thermal Insulation

Thermal Insulation compliant with Minimum Environmental Criteria

(CAM - Criteri Ambientali Minimi)



A complete range of thermal and acoustic insulation products



Soprema thermal insulation products embrace a range of different production types: extruded polystyrene foam, moulded expanded polystyrene, sintered expanded polystyrene, expanded polyurethane, cement-bonded mineral wood fibre.

The different types cover all the most typical building applications: thermal insulation of flat and sloping roofs, subfloors, floor coverings, architraves and pillars, foundations, interspaces, peripheral insulation of walls below ground level, thermal insulation of green roofs, under shingles, under bent tiles, ventilated walls and external thermal insulation composite systems.

Technical reference standards

UNI EN 13163: Thermal insulation products for buildings - Factory made expanded polystyrene (EPS) products - Specification

UNI EN 13164: Thermal insulation products for buildings - Factory made extruded polystyrene foam (XPS) products - Specification

UNI EN 13165: Thermal insulation products for buildings - Factory made rigid polyurethane foam (PU) products - Specification

UNI EN 13168: Thermal insulation products for buildings - Factory made wood wool (WW) products - Specification

Key for intended use



False ceilings



Walls



Inverted roof



Flooring



Under-shingle



Pitched roof



Attic



Flat roof



Roof gardens



Corrections of thermal bridges



Car parks



Roof gardens

Sopra XPS Multi 20

Rough-surface insulation panels in extruded polystyrene foam XPS.



Rough-surface insulation panels in extruded polystyrene foam XPS with CE marking compliant with Standard UNI EN 13164, with thermal conductivity $\lambda_D = 0.033$ W/mK Standard EN 12667, Compressive strength ≥ 250 kPa Standard EN 826, Reaction to fire in Euroclass E, with Environmental Product Declaration EPD, compliant with **Minimum Environmental Criteria (CAM - Criteri Ambientali Minimi)**.

Intended use

- Correction of thermal bridges on beams, pillars and floor slabs
- Sandwich panels

CHARACTERISTICS	VALUES
Declared thermal conductivity λ_D at 10°C (W/mK) - EN 12667	0.033
Compressive strength (kPa) - EN 826	≥ 250
Reaction to fire - EN 13501-1	Euroclass E
Thickness mm	20
Length mm	1250
Width mm	600
Type of surface	rough
Moulded edges	
Intended use	

Dimensions mm	Code	Panels in Pack	m ² /pack	Packs/pallet	m ² /pallet	Avail. in days
20x600x1250	104698	21	15.75	12	189.00	on request

DESIGNATION CODE PURSUANT TO UNI EN 13164

XPS-EN 13164-T1-CS(10/Y)250

DOCUMENTS AVAILABLE ON WEBSITE www.soprema.it

General Catalogue

Price List

Declaration of Performance DOP - CE Marking

Technical Data Sheet TDS

Declaration of Conformity to Minimum Environmental Requirements CAM

Environmental Product Declaration EPD

Safety Data Sheet VSDS



Compliant with Minimum Environmental Criteria CAM

Sopra XPS CR



Insulation panels in extruded polystyrene foam XPS.



Panels in extruded polystyrene foam XPS, with CE marking compliant with Standard UNI EN 13164, Compressive strength ≥ 300 kPa Standard EN 826, Reaction to fire in Euroclass E, with Environmental Product Declaration EPD, compliant with **Minimum Environmental Criteria (CAM - Criteri Ambientali Minimi)**

Intended use

- ▶ Thermal insulation of flat roofs under ballast
- ▶ Thermal insulation of attics

CHARACTERISTICS	VALUES
Declared thermal conductivity λ_D at 10°C (W/mK) - EN 12667	30÷60 : 0.033 80÷140 : 0.035
Compressive strength (kPa) - EN 826	≥ 300
Reaction to fire - EN 13501-1	Euroclass E
Thickness mm	30 ÷ 140
Length mm	1250
Width mm	600
Type of surface	smooth
Moulded edges	
Intended use	 

Code	Dimensions mm	Panels in Pack	m ² /pack	Packs/pallet	m ² /pallet	Avail. in days
104715	30x600x1250	14	10.50	12	126.00	on request
104716	40x600x1250	10	7.50	12	90.00	on request
104717	50x600x1250	8	6.00	12	72.00	on request
104718	60x600x1250	7	5.25	12	63.00	on request
104719	80x600x1250	5	3.75	12	45.00	on request
105408	100x600x1250	4	3.00	12	36.00	on request
105412	120x600x1250	3	2.25	14	31.50	on request
115316	140x600x1250	3	2.25	12	27.00	on request

DESIGNATION CODE PURSUANT TO UNI EN 13164

30-50 mm: XPS-EN 13164-T1-CS(10\Y)300-WL(T)0,7- DS(70,90)-DLT(2)5-WD(V)3-FTCD1-MU150-TR200

60-80 mm: XPS-EN 13164-T1-CS(10\Y)300-WL(T)0,7- DS(70,90)-DLT(2)5-WD(V)2-FTCD1-MU150-TR200-CC(2/1,5/50)130

100-120 mm: XPS-EN 13164-T1-CS(10\Y)300-WL(T)0,7- DS(70,90)-DLT(2)5-WD(V)1-FTCD1-MU150-TR200-CC(2/1,5/50)130

140 mm: XPS-EN 13164-T1-CS(10\Y)300-WL(T)0,7- DS(70,90)-DLT(2)5-WD(V)1-FTCD1-MU150-TR200

DOCUMENTS AVAILABLE ON WEBSITE www.soprema.it

General Catalogue

Price List

Declaration of Performance DOP - CE Marking

Technical Data Sheet TDS

Declaration of Conformity to Minimum Environmental Requirements CAM

Environmental Product Declaration EPD

Safety Data Sheet VSDS



Sopra XPS SL



Insulation panels in extruded polystyrene foam XPS.



Panels in extruded polystyrene foam XPS, with CE marking compliant with Standard UNI EN 13164, Compressive strength ≥ 300 kPa Standard EN 826, Reaction to fire in Euroclass E, with Environmental Product Declaration EPD, compliant with **Minimum Environmental Criteria (CAM - Criteri Ambientali Minimi)**

Intended use

- Thermal insulation of flat roofs under ballast
- Thermal insulation of pitched roofs and attics

CHARACTERISTICS	VALUES
Declared thermal conductivity λ_D at 10°C (W/mK) - EN 12667	30÷60 : 0.033 80÷200 : 0.035 220÷300 : 0.036
Compressive strength (kPa) - EN 826	≥ 300
Reaction to fire - EN 13501-1	Euroclass E
Thickness mm	30 ÷ 300
Length mm	1250
Width mm	600
Type of surface	smooth
Moulded edges	
Intended use	

Code	Dimensions mm	Panels in Pack	m ² /pack	Packs/pallet	m ² /pallet	Avail. in days
104671	30x600x1250	14	10.50	12	126.00	on request
104672	40x600x1250	10	7.50	12	90.00	on request
104673	50x600x1250	8	6.00	12	72.00	on request
104674	60x600x1250	7	5.25	12	63.00	on request
104675	80x600x1250	5	3.75	12	45.00	on request
104676	100x600x1250	4	3.00	12	36.00	on request
104677	120x600x1250	3	2.25	14	31.50	on request
106626	140x600x1250	3	2.25	12	27.00	on request
106627	160x600x1250	2	1.50	16	24.00	on request
110289	180x600x1250	2	1.50	14	21.00	on request
115312	200x600x1250	2	1.50	12	18.00	on request
109111	220x600x1250*	2	1.50	12	18.00	on request
115363	240x600x1250*	1	0.75	20	15.00	on request
109113	260x600x1250*	1	0.75	18	13.50	on request
109114	280x600x1250*	1	0.75	18	13.50	on request
109115	300x600x1250*	1	0.75	16	12.00	on request

* Minimum batch 300 m²

DESIGNATION CODE PURSUANT TO UNI EN 13164

30-50 mm: XPS-EN 13164-T1-CS(10\Y)300-WL(T)0,7- DS(70,90)-DLT(2)5-WD(V)3-FTCD1-MU150-TR200

60-80 mm: XPS-EN 13164-T1-CS(10\Y)300-WL(T)0,7- DS(70,90)-DLT(2)5-WD(V)2-FTCD1-MU150-TR200-CC(2/1,5/50)130

100-120 mm: XPS-EN 13164-T1-CS(10\Y)300-WL(T)0,7- DS(70,90)-DLT(2)5-WD(V)1-FTCD1-MU150-TR200-CC(2/1,5/50)130

140-300 mm: XPS-EN 13164-T1-CS(10\Y)300-WL(T)0,7- DS(70,90)-DLT(2)5-WD(V)1-FTCD1-MU150-TR200

DOCUMENTS AVAILABLE ON WEBSITE www.soprema.it

General Catalogue

Price List

Declaration of Performance DOP - CE Marking

Technical Data Sheet TDS

Declaration of Conformity to Minimum Environmental Requirements CAM

Environmental Product Declaration EPD

KEYMARK Certificate

Safety Data Sheet VSDS

Sopra XPS SL-HP



Insulation panels in extruded polystyrene foam XPS.



Insulation panels in extruded polystyrene foam XPS with CE marking compliant with Standard UNI EN 13164, with thermal conductivity $\lambda_D = 0.033$ W/mK Standard EN 12667, Compressive strength ≥ 300 kPa Standard EN 826, Reaction to fire in Euroclass E, with Environmental Product Declaration EPD, compliant with **Minimum Environmental Criteria (CAM - Criteri Ambientali Minimi)**

Intended use

- ▶ Thermal insulation of flat roofs under ballast
- ▶ Thermal insulation of pitched roofs and attics

CHARACTERISTICS	VALUES
Declared thermal conductivity λ_D at 10°C (W/mK) - EN 12667	0.033
Compressive strength (kPa) - EN 826	≥ 300
Reaction to fire - EN 13501-1	Euroclass E
Thickness mm	80 ÷ 140
Length mm	1250
Width mm	600
Type of surface	smooth
Moulded edges	
Intended use	 

Code	Dimensions mm	Panels in Pack	m ² /pack	Packs/pallet	m ² /pallet	Avail. in days
158852	80x600x1250	5	3.75	12	45.00	on request
158853	100x600x1250	4	3.00	12	36.00	on request
158854	120x600x1250	3	2.25	14	31.50	on request
158855	140x600x1250	3	2.25	12	27.00	on request

DESIGNATION CODE PURSUANT TO UNI EN 13164

XPS-EN 13164-T1-CS(10\Y)300-WL(T)0,7- DS(70,90)-DLT(2)5-WD(V)1-FTCD1-MU150-TR200

DOCUMENTS AVAILABLE ON WEBSITE www.soprema.it

General Catalogue

Price List

Declaration of Performance DOP - CE Marking

Technical Data Sheet TDS

Declaration of Conformity to Minimum Environmental Requirements CAM

Environmental Product Declaration EPD

Safety Data Sheet VSDS



Compliant with Minimum Environmental Criteria CAM

Sopra XPS CW



Insulation panels in extruded polystyrene foam XPS.



Panels in extruded polystyrene foam XPS, with CE marking compliant with Standard UNI EN 13164, Compressive strength ≥ 250 kPa Standard EN 826, Reaction to fire in Euroclass E, with Environmental Product Declaration EPD, compliant with **Minimum Environmental Criteria (CAM - Criteri Ambientali Minimi)**.

Intended use

- Thermal insulation of pitched roofs

CHARACTERISTICS	VALUES
Declared thermal conductivity λ_D at 10°C (W/mK) - EN 12667	30 ÷ 60 mm : 0.033 80 ÷ 140 mm : 0.035
Compressive strength (kPa) - EN 826	≥ 250
Reaction to fire - EN 13501-1	Euroclass E
Thickness mm	30 ÷ 140
Length mm	2500
Width mm	600
Type of surface	smooth
Moulded edges on long sides	
Intended use	

Code	Dimensions mm	Panels in Pack	m ² /pack	Packs/pallet	m ² /pallet	Avail. in days
104686	30x600x2500	14	21.00	12	252.00	on request
104687	40x600x2500	10	15.00	12	180.00	on request
104688	50x600x2500	8	12.00	12	144.00	on request
104689	60x600x2500	7	10.50	12	126.00	on request
104690	80x600x2500	5	7.50	12	90.00	on request
104691	100x600x2500	4	6.00	12	72.00	on request
104692	120x600x2500	3	4.50	14	63.00	on request
115148	140x600x2500	3	4.50	12	54.00	on request

DESIGNATION CODE PURSUANT TO UNI EN 13164

30-50 mm: XPS-EN 13164-T1-CS(10\Y)250-WL(T)0,7 - DS(70,90)-DLT(2)5-WD(V)3-MU150- TR200

60-80 mm: XPS-EN 13164-T1-CS(10\Y)250-WL(T)0,7 - DS(70,90)-DLT(2)5-WD(V)2-MU150- TR200

100÷140 mm: XPS-EN 13164-T1-CS(10\Y)250-WL(T)0,7 - DS(70,90)-DLT(2)5-WD(V)1-MU150- TR200

DOCUMENTS AVAILABLE ON WEBSITE www.soprema.it

General Catalogue

Price List

Declaration of Performance DOP - CE Marking

Technical Data Sheet TDS

Declaration of Conformity to Minimum Environmental Requirements CAM

Environmental Product Declaration EPD

Safety Data Sheet VSDS



Compliant with Minimum Environmental Criteria CAM

Sopra XPS WF

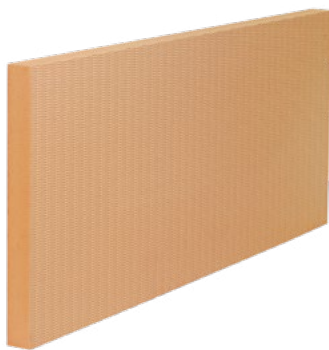

Wafer-surface insulation panels in extruded polystyrene foam XPS.



Wafer-surface panels in extruded polystyrene foam XPS, with CE marking compliant with Standard UNI EN 13164, Compressive strength ≥ 300 kPa Standard EN 826, Reaction to fire in Euroclass E, with Environmental Product Declaration EPD, compliant with **Minimum Environmental Criteria (CAM - Criteri Ambientali Minimi)**.

Intended use

- Correction of thermal bridges on beams, pillars and floor slabs
- Skirting of external thermal insulation composite system

CHARACTERISTICS	VALUES
Declared thermal conductivity λ_D at 10°C (W/mK) - EN 12667	30÷60 : 0.033 80÷200 : 0.035 220÷300 : 0.036
Compressive strength (kPa) - EN 826	≥ 300
Reaction to fire - EN 13501-1	Euroclass E
Thickness mm	30 ÷ 300
Length mm	1250
Width mm	600
Type of surface	wafered
Moulded edges	
Intended use	

Code	Dimensions mm	Panels in Pack	m ² /pack	Packs/pallet	m ² /pallet	Avail. in days
109014	30x600x1250	14	10.50	12	126.00	on request
109015	40x600x1250	10	7.50	12	90.00	on request
109016	50x600x1250	8	6.00	12	72.00	on request
109017	60x600x1250	7	5.25	12	63.00	on request
109081	80x600x1250	5	3.75	12	45.00	on request
109082	100x600x1250	4	3.00	12	36.00	on request
109083	120x600x1250	3	2.25	14	31.50	on request
109084	140x600x1250	3	2.25	12	27.00	on request
115239	160x600x1250	2	1.50	16	24.00	on request
109086	180x600x1250	2	1.50	14	21.00	on request
116159	200x600x1250	2	1.50	12	18.00	on request
109122	220x600x1250*	2	1.50	12	18.00	on request
109123	240x600x1250*	1	0.75	20	15.00	on request
109790	260x600x1250*	1	0.75	18	13.50	on request
119173	280x600x1250*	1	0.75	18	13.50	on request
115344	300x600x1250*	1	0.75	16	12.00	on request

* Minimum batch 300 m²

DESIGNATION CODE PURSUANT TO UNI EN 13164

30-50 mm: XPS-EN 13164-T1-CS(10\Y)300-WL(T)0,7- DS(70,90)-DLT(2)5-WD(V)3 -FTCD1-MU150-TR200

60-80 mm: XPS-EN 13164-T1-CS(10\Y)300-WL(T)0,7- DS(70,90)-DLT(2)5-WD(V)2 -FTCD1-MU150-TR200

100÷300 mm: XPS-EN 13164-T1-CS(10\Y)300-WL(T)0,7- DS(70,90)-DLT(2)5-WD(V)1 -FTCD1-MU150-TR200

DOCUMENTS AVAILABLE ON WEBSITE www.soprema.it

General Catalogue

Price List

Declaration of Performance DOP - CE Marking

Technical Data Sheet TDS

Declaration of Conformity to Minimum Environmental Requirements CAM

Environmental Product Declaration EPD

KEYMARK Certificate

Safety Data Sheet VSDS

Sopra XPS 500



Insulation panels in extruded polystyrene foam XPS.



Panels in extruded polystyrene foam XPS, with CE marking compliant with Standard UNI EN 13164, Compressive strength ≥ 500 kPa Standard EN 826, Reaction to fire in Euroclass E, with Environmental Product Declaration EPD, compliant with **Minimum Environmental Criteria (CAM - Criteri Ambientali Minimi)**.

Intended use

- ▶ Thermal insulation of civil and industrial subfloors
- ▶ Thermal insulation of car parks

CHARACTERISTICS	VALUES
Declared thermal conductivity λ_D at 10°C (W/mK) - EN 12667	50-60 : 0.033 80÷200 : 0.035 220÷300 : 0.036
Compressive strength (kPa) - EN 826	≥ 500
Reaction to fire - EN 13501-1	Euroclass E
Thickness mm	50÷300
Length mm	1250
Width mm	600
Type of surface	smooth
Moulded edges	
Intended use	 

Code	Dimensions mm	Panels in Pack	m ² /pack	Packs/pallet	m ² /pallet	Avail. in days
104700	50x600x1250	8	6.00	12	72.00	on request
104701	60x600x1250	7	5.25	12	63.00	on request
104702	80x600x1250	5	3.75	12	45.00	on request
104703	100x600x1250	4	3.00	12	36.00	on request
104704	120x600x1250	3	2.25	14	31.50	on request
114147	140x600x1250	3	2.25	12	27.00	on request
115241	160x600x1250	2	1.50	16	24.00	on request
109013	180x600x1250	2	1.50	14	21.00	on request
116160	200x600x1250	2	1.50	12	18.00	on request
109117	220x600x1250*	2	1.50	12	18.00	on request
109784	240x600x1250*	1	0.75	20	15.00	on request
109118	260x600x1250*	1	0.75	18	13.50	on request
109785	280x600x1250*	1	0.75	18	13.50	on request
109759	300x600x1250*	1	0.75	16	12.00	on request

* Minimum batch 300 m²

DESIGNATION CODE PURSUANT TO UNI EN 13164

50 mm: XPS-EN 13164-T1-CS(10\Y)500-WL(T)0,7 - DS(70,90)-DLT(2)5-WD(V)3-FTCD1-MU150-TR200- CC(2/1,5/50)180

60 mm: XPS-EN 13164-T1-CS(10\Y)500-WL(T)0,7 - DS(70,90)-DLT(2)5-WD(V)2-FTCD1-MU150-TR200- CC(2/1,5/50)180

80÷300 mm: XPS-EN 13164-T1-CS(10\Y)500-WL(T)0,7 - DS(70,90)-DLT(2)5-WD(V)-FTCD1-MU150-TR200- CC(2/1,5/50)180

DOCUMENTS AVAILABLE ON WEBSITE www.soprema.it

General Catalogue

Price List

Declaration of Performance DOP - CE Marking

Technical Data Sheet TDS

Declaration of Conformity to Minimum Environmental Requirements CAM

Environmental Product Declaration EPD

KEYMARK Certificate

Safety Data Sheet VSDS

Sopra XPS 700





Insulation panels in extruded polystyrene foam XPS.



Panels in extruded polystyrene foam XPS, with CE marking compliant with Standard UNI EN 13164, Compressive strength ≥ 700 kPa Standard EN 826, Reaction to fire in Euroclass E, with Environmental Product Declaration EPD, compliant with **Minimum Environmental Criteria (CAM - Criteri Ambientali Minimi)**

Intended use

- ▶ Thermal insulation of civil and industrial subfloors
- ▶ Thermal insulation of car parks

CHARACTERISTICS	VALUES
Declared thermal conductivity λ_D at 10°C (W/mK) - EN 12667	60 : 0.033 80÷200 : 0.035 220÷300 : 0.036
Compressive strength (kPa) - EN 826	≥ 700
Reaction to fire - EN 13501-1	Euroclass E
Thickness mm	60 ÷ 300
Length mm	1250
Width mm	600
Type of surface	smooth
Moulded edges	
Intended use	   

Code	Dimensions mm	Panels in Pack	m ² /pack	Packs/pallet	m ² /pallet	Avail. in days
105481	60x600x1250	7	5.25	12	63.00	on request
105477	80x600x1250	5	3.75	12	45.00	on request
105478	100x600x1250	4	3.00	12	36.00	on request
106660	120x600x1250	3	2.25	14	31.50	on request
109094	140x600x1250	3	2.25	12	27.00	on request
115242	160x600x1250	2	1.50	16	24.00	on request
114766	180x600x1250	2	1.50	14	21.00	on request
109120	200x600x1250	2	1.50	12	18.00	on request
109786	220x600x1250*	2	1.50	12	18.00	on request
109787	240x600x1250*	1	0.75	20	15.00	on request
109788	260x600x1250*	1	0.75	18	13.50	on request
109760	280x600x1250*	1	0.75	18	13.50	on request
109761	300x600x1250*	1	0.75	16	12.00	on request

* Minimum batch 300 m²

DESIGNATION CODE PURSUANT TO UNI EN 13164

60 mm: XPS-EN 13164-T1-CS(10\Y)700-WL(T)0,7 - DS(70,90)-DLT(2)5-WD(V)2-FTCD1-MU150-TR200-CC(2/1,5/50)250

80÷300 mm: XPS-EN 13164-T1-CS(10\Y)700-WL(T)0,7 - DS(70,90)-DLT(2)5-WD(V)1-FTCD1-MU150-TR200-CC(2/1,5/50)250

DOCUMENTS AVAILABLE ON WEBSITE www.soprema.it

General Catalogue

Price List

Declaration of Performance DOP - CE Marking

Technical Data Sheet TDS

Declaration of Conformity to Minimum Environmental Requirements CAM

Environmental Product Declaration EPD

KEYMARK Certificate

Safety Data Sheet VSDS

Neostir TR 100 ECO



Insulation panels in expanded polystyrene EPS obtained from a block.



Insulation panels in grey expanded polystyrene EPS additivated with graphite, with CE marking compliant with Standard UNI EN 13163, Thermal conductivity $\lambda_D = 0.031$ W/mK, with Environmental Product Declaration EPD, compliant with **Minimum Environmental Criteria (CAM - Criteri Ambientali Minimi)**

Intended use

- Thermal insulation with external thermal insulation composite system

CHARACTERISTICS	VALUES
Class	TR 100
Declared thermal conductivity λ_D at 10°C (W/mK) - EN 12667	0.031
Reaction to fire - EN 13501-1	Euroclass E
Thickness mm	20÷300
Length mm	1000
Width mm	500
Moulded edges	
Intended use	

Minimum production batch: 4.8 m³

Code	Dimensions mm	Panels in Pack	Avail. in days
116435	20x500x1000	30	on request
116436	30x500x1000	20	on request
116437	40x500x1000	15	on request
116438	50x500x1000	12	on request
116454	60x500x1000	10	on request
116456	80x500x1000	7	on request
116458	100x500x1000	6	on request
116459	120x500x1000	5	on request
116460	140x500x1000	4	on request
116463	160x500x1000	3	on request
116464	180x500x1000	3	on request
116465	200x500x1000	3	on request
116466	220x500x1000	2	on request
116467	240x500x1000	2	on request
116468	260x500x1000	2	on request
116469	280x500x1000	2	on request
116470	300x500x1000	2	on request

DESIGNATION CODE PURSUANT TO UNI EN 13163

Panels 1000x500 mm: EPS-EN 13163-T1-W2-L2-S2-P3-DS(N)2-DS(70,-)1-CS(10/Y)100-TR150-BS150-WL(P)0,5-MU(30-70)

DOCUMENTS AVAILABLE ON WEBSITE www.soprema.it

General Catalogue

Price List

Declaration of Performance DOP - CE Marking

Technical Data Sheet TDS

Declaration of Conformity to Minimum Environmental Requirements CAM

Environmental Product Declaration EPD

Safety Data Sheet VSDS

Neostir EPS 100 ECO

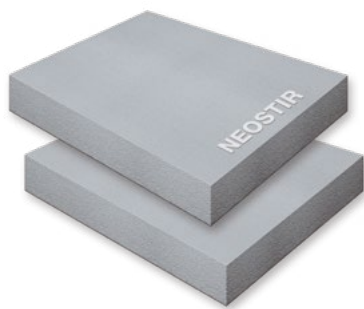

Insulation panels in expanded polystyrene EPS obtained from a block.



Insulation panels in grey expanded polystyrene EPS additivated with graphite, with CE marking compliant with Standard UNI EN 13163, with Thermal conductivity $\lambda_D = 0.030$ W/mK Standard EN 12667, with Environmental Product Declaration EPD, compliant with **Minimum Environmental Criteria (CAM - Criteri Ambientali Minimi)**

Intended use

- Thermal insulation with external thermal insulation composite system

CHARACTERISTICS	VALUES
Class	100
Declared thermal conductivity λ_D at 10°C (W/mK) - EN 12667	0.030
Reaction to fire - EN 13501-1	Euroclass E
Thickness mm	20÷300
Length mm	1000
Width mm	500
Moulded edges	
Intended use	

Minimum production batch: 4.8 m3

Code	Dimensions mm	Panels in Pack	Avail. in days
110423	20x500x1000	30	on request
109642	30x500x1000	20	on request
109644	40x500x1000	15	on request
114226	50x500x1000	12	on request
113312	60x500x1000	10	on request
113961	80x500x1000	7	on request
113960	100x500x1000	6	on request
110427	120x500x1000	5	on request
113313	140x500x1000	4	on request
113311	160x500x1000	3	on request
112605	180x500x1000	3	on request
112606	200x500x1000	3	on request
159171	220x500x1000	2	on request
159173	240x500x1000	2	on request
156303	260x500x1000	2	on request
159174	280x500x1000	2	on request
152302	300x500x1000	2	on request

DESIGNATION CODE PURSUANT TO UNI EN 13163

Panels 1000x500 mm: EPS-EN 13163-T1-W2-L2-S2-P3-DS(N)2-DS(70,-)1-CS(10/Y)100-TR150-BS150-WL(P)0,5-MU(30-70)

DOCUMENTS AVAILABLE ON WEBSITE www.soprema.it

General Catalogue

Price List

Declaration of Performance DOP - CE Marking

Technical Data Sheet TDS

Declaration of Conformity to Minimum Environmental Requirements CAM

Environmental Product Declaration EPD

Safety Data Sheet VSDS

Neostir EPS 150 ECO



Insulation panels in expanded polystyrene EPS obtained from a block.



Insulation panels in grey expanded polystyrene EPS additivated with graphite, with CE marking compliant with Standard UNI EN 13163, with Thermal conductivity $\lambda_D = 0.030$ W/mK Standard EN 12667 with Compressive strength ≥ 150 kPa, with Environmental Product Declaration EPD, compliant with **Minimum Environmental Criteria (CAM - Criteri Ambientali Minimi)**

Intended use

- Insulation of flat warm roofs with waterproofing with PVC-TPO synthetic membranes

CHARACTERISTICS	VALUES
Class	150
Declared thermal conductivity λ_D at 10°C (W/mK) - EN 12667	0.030
Compressive strength (kPa) - EN 826	≥ 150
Reaction to fire - EN 13501-1	Euroclass E
Thickness mm	20÷300
Length mm	2000
Width mm	1000
Moulded edges	
Intended use	

Code	Dimensions mm	Panels in Pack	Avail. in days
159104	20x1000x2000	30	on request
159106	30x1000x2000	20	on request
156630	40x1000x2000	15	on request
156631	50x1000x2000	12	on request
156632	60x1000x2000	10	on request
156634	80x1000x2000	7	on request
157168	100x1000x2000	6	on request
156417	120x1000x2000	5	on request
156630	140x1000x2000	4	on request
156643	160x1000x2000	3	on request
156645	180x1000x2000	3	on request
156651	200x1000x2000	3	on request
159086	220x1000x2000	2	on request
159110	240x1000x2000	2	on request
159994	260x1000x2000	2	on request
159112	280x1000x2000	2	on request
159134	300x1000x2000	2	on request

Minimum production batch: 4.8 m³

On request, possibility to supply panels with perimeter rebate

DESIGNATION CODE PURSUANT TO UNI EN 13163

Panels 1000x2000 mm: EPS-EN 13163-T2-L3-W3-S2-P5-DS(N)2-DS(70,-)1-CS(10/Y)150-TR200-BS200-WL(P)0,5-MU(30-70)

DOCUMENTS AVAILABLE ON WEBSITE www.soprema.it

General Catalogue

Price List

Declaration of Performance DOP - CE Marking

Technical Data Sheet TDS

Declaration of Conformity to Minimum Environmental Requirements CAM

Environmental Product Declaration EPD

Safety Data Sheet VSDS

Sirapor TR 100 ECO



Insulation panels in expanded polystyrene EPS obtained from a block.



Insulation panels in expanded polystyrene EPS, with CE marking compliant with Standard UNI EN 13163, Thermal conductivity $\lambda_D = 0.036$ W/mK Standard EN 12667, with Environmental Product Declaration EPD, compliant with **Minimum Environmental Criteria (CAM - Criteri Ambientali Minimi)**

Intended use

- Thermal insulation with external thermal insulation composite system

CHARACTERISTICS	VALUES
Class	TR 100
Declared thermal conductivity λ_D at 10°C (W/mK) - EN 12667	0.036
Reaction to fire - EN 13501-1	Euroclass E
Thickness mm	20÷300
Length mm	1000
Width mm	500
Moulded edges	
Intended use	

Minimum production batch: 4.8 m³

Code	Dimensions mm	Panels in Pack	Avail. in days
158195	20x500x1000	30	on request
157935	30x500x1000	20	on request
156508	40x500x1000	15	on request
156509	50x500x1000	12	on request
156510	60x500x1000	10	on request
156511	80x500x1000	7	on request
156513	100x500x1000	6	on request
156455	120x500x1000	5	on request
157816	140x500x1000	4	on request
156514	160x500x1000	3	on request
156515	180x500x1000	3	on request
156519	200x500x1000	3	on request
158212	220x500x1000	2	on request
158277	240x500x1000	2	on request
158291	260x500x1000	2	on request
158292	280x500x1000	2	on request
159176	300x500x1000	2	on request

DESIGNATION CODE PURSUANT TO UNI EN 13163

Panels 500x1000 mm: EPS-EN 13163-T1-L2-W2-S2-P3-DS(N)2-DS(70,-)1-TR100-BS115-WL(P)0,5-MU(20-40)

DOCUMENTS AVAILABLE ON WEBSITE www.soprema.it

General Catalogue

Price List

Declaration of Performance DOP - CE Marking

Technical Data Sheet TDS

Declaration of Conformity to Minimum Environmental Requirements CAM

Environmental Product Declaration EPD

Safety Data Sheet VSDS

Sirapor EPS 100 ECO



Insulation panels in expanded polystyrene EPS obtained from a block.



Insulation panels in expanded polystyrene EPS, with CE marking compliant with Standard UNI EN 13163, Thermal conductivity $\lambda_D = 0.035$ W/mK Standard EN 12667, with Environmental Product Declaration EPD, compliant with **Minimum Environmental Criteria (CAM - Criteri Ambientali Minimi)**

Intended use

- Thermal insulation with external thermal insulation composite system

CHARACTERISTICS	VALUES
Class	100
Declared thermal conductivity λ_D at 10°C (W/mK) - EN 12667	0.035
Reaction to fire - EN 13501-1	Euroclass E
Thickness mm	20÷300
Length mm	1000
Width mm	500
Moulded edges	
Intended use	

Minimum production batch: 4.8 m³

Code	Dimensions mm	Panels in Pack	Avail. in days
156947	20x500x1000	30	on request
156933	30x500x1000	20	on request
156447	40x500x1000	15	on request
156450	50x500x1000	12	on request
156440	60x500x1000	10	on request
156441	80x500x1000	7	on request
156449	100x500x1000	6	on request
156463	120x500x1000	5	on request
157147	140x500x1000	4	on request
156467	160x500x1000	3	on request
156468	180x500x1000	3	on request
156469	200x500x1000	3	on request
157496	220x500x1000	2	on request
157512	240x500x1000	2	on request
157516	260x500x1000	2	on request
159177	280x500x1000	2	on request
157517	300x500x1000	2	on request

DESIGNATION CODE PURSUANT TO UNI EN 13163

Panels 500x1000 mm: EPS-EN 13163-T1-L2-W2-S2-P3-DS(N)2-DS(70,-)1-CS(10/Y)100-TR150-BS150-WL(P)0,5-MU(30-70)

DOCUMENTS AVAILABLE ON WEBSITE www.soprema.it

General Catalogue

Price List

Declaration of Performance DOP - CE Marking

Technical Data Sheet TDS

Declaration of Conformity to Minimum Environmental Requirements CAM

Environmental Product Declaration EPD

Safety Data Sheet VSDS

Sirapor EPS 150 ECO



Insulation panels in expanded polystyrene EPS obtained from a block.



Insulation panels in expanded polystyrene EPS, with CE marking compliant with Standard UNI EN 13163, with Compressive strength ≥ 150 kPa, Thermal conductivity $\lambda_D = 0.034$ W/mK Standard EN 12667, with Environmental Product Declaration EPD, compliant with **Minimum Environmental Criteria (CAM - Criteri Ambientali Minimi)**

Intended use

- Thermal insulation of flat warm roofs with waterproofing with PVC-TPO synthetic membranes

CHARACTERISTICS	VALUES
Class	150
Declared thermal conductivity λ_D at 10°C (W/mK) - EN 12667	0.034
Compressive strength (kPa) - EN 826	≥ 150
Reaction to fire - EN 13501-1	Euroclass E
Thickness mm	20÷300
Length mm	2000
Width mm	1000
Moulded edges	
Intended use	

Code	Dimensions mm	Panels in Pack	Avail. in days
159179	20x1000x2000	30	on request
157955	30x1000x2000	20	on request
156471	40x1000x2000	15	on request
156473	50x1000x2000	12	on request
156476	60x1000x2000	10	on request
156477	80x1000x2000	7	on request
156480	100x1000x2000	6	on request
156481	120x1000x2000	5	on request
159186	140x1000x2000	4	on request
156483	160x1000x2000	3	on request
156498	180x1000x2000	3	on request
156500	200x1000x2000	3	on request
159188	220x1000x2000	2	on request
159191	240x1000x2000	2	on request
159200	260x1000x2000	2	on request
159098	280x1000x2000	2	on request
159201	300x1000x2000	2	on request

Minimum production batch: 4.8 m³

On request, possibility to supply panels with perimeter rebate

DESIGNATION CODE PURSUANT TO UNI EN 13163

Panels 1000x2000 mm: EPS-EN 13163-T2-L3-W3-S2-P5-DS(N)2-DS(70,-)1-CS(10/Y)150-TR200-BS200-WL(P)0,5-MU(30-70)

DOCUMENTS AVAILABLE ON WEBSITE www.soprema.it

General Catalogue

Price List

Declaration of Performance DOP - CE Marking

Technical Data Sheet TDS

Declaration of Conformity to Minimum Environmental Requirements CAM

Environmental Product Declaration EPD

Safety Data Sheet VSDS

Sirapor EPS 200 ECO



Insulation panels in expanded polystyrene EPS obtained from a block.



Insulation panels in expanded polystyrene EPS, with CE marking compliant with Standard UNI EN 13163, with Compressive strength ≥ 200 kPa, Thermal conductivity $\lambda_D = 0.033$ W/mK Standard EN 12667, with Environmental Product Declaration EPD, compliant with **Minimum Environmental Criteria (CAM - Criteri Ambientali Minimi)**

Intended use

- Thermal insulation of flat warm roofs with waterproofing with PVC-TPO synthetic membranes

CHARACTERISTICS	VALUES
Class	200
Declared thermal conductivity λ_D at 10°C (W/mK) - EN 12667	0.033
Compressive strength (kPa) - EN 826	≥ 200
Reaction to fire - EN 13501-1	Euroclass E
Thickness mm	20÷300
Length mm	2000
Width mm	1000
Moulded edges	
Intended use	

Code	Dimensions mm	Panels in Pack	Avail. in days
159202	20x1000x2000	30	on request
159203	30x1000x2000	20	on request
156520	40x1000x2000	15	on request
156525	50x1000x2000	12	on request
156526	60x1000x2000	10	on request
156568	80x1000x2000	7	on request
156569	100x1000x2000	6	on request
156570	120x1000x2000	5	on request
159243	140x1000x2000	4	on request
156571	160x1000x2000	3	on request
156577	180x1000x2000	3	on request
156578	200x1000x2000	3	on request
159244	220x1000x2000	2	on request
159245	240x1000x2000	2	on request
159246	260x1000x2000	2	on request
159247	280x1000x2000	2	on request
159102	300x1000x2000	2	on request

Minimum production batch: 4.8 m³

On request, possibility to supply panels with perimeter rebate

DESIGNATION CODE PURSUANT TO UNI EN 13163

Panels 1000x2000 mm: EPS-EN 13163-T2-L3-W3-S2-P5-DS(N)2-DS(70,-)1-CS(10/Y)200-TR250-BS250-WL(P)0,5-MU(40-100)

DOCUMENTS AVAILABLE ON WEBSITE www.soprema.it

General Catalogue

Price List

Declaration of Performance DOP - CE Marking

Technical Data Sheet TDS

Declaration of Conformity to Minimum Environmental Requirements CAM

Environmental Product Declaration EPD

Safety Data Sheet VSDS

Neostir GW ECO



Double layer insulation panels in moulded expanded polystyrene EPS.



Double layer panels in moulded expanded polystyrene EPS, with CE marking, compliant with Standard UNI EN 13163, comprised of one layer of grey moulded EPS additivated with graphite, coated with one layer of white moulded EPS, Thermal conductivity $\lambda_D = 0.030$ W/mK Standard EN 12667, compliant with **Minimum Environmental Criteria (CAM - Criteri Ambientali Minimi)**

Intended use

- Thermal insulation with external thermal insulation composite system

CHARACTERISTICS	VALUES
Declared thermal conductivity λ_D at 10°C (W/mK) - EN 12667	0.030
Reaction to fire - EN 13501-1	Euroclass E
Thickness mm	60÷240
Length mm	1000
Width mm	500
Moulded edges	
Intended use	

Code	Dimensions mm	Panels in Pack	Avail. in days
109708	60x500x1000	10	on request
109710	80x500x1000	7	on request
109711	100x500x1000	6	on request
109712	120x500x1000	5	on request
109713	140x500x1000	4	on request
109714	160x500x1000	3	on request
109715	180x500x1000	3	on request
109716	200x500x1000	3	on request
109717	220x500x1000	2	on request
109718	240x500x1000	2	on request

DESIGNATION CODE PURSUANT TO UNI EN 13163

Panels 500x1000 mm: EPS-EN 13163-T1-L2-W2-S2-P3-DS(N)2-DS(70,-)1-TR150-BS150-WL(P)0,5-MU(30-70)

DOCUMENTS AVAILABLE ON WEBSITE www.soprema.it

General Catalogue

Price List

Declaration of Performance DOP - CE Marking

Technical Data Sheet TDS

Declaration of Conformity to Minimum Environmental Requirements CAM

Safety Data Sheet VSDS



Compliant with Minimum Environmental Criteria CAM

Gemastir 150 ECO

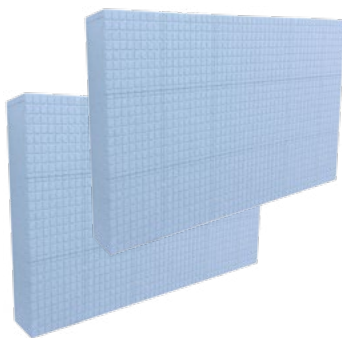

Insulation panels in moulded expanded polystyrene EPS.



Insulation panels in light blue moulded expanded polystyrene EPS, with CE marking compliant with Standard UNI EN 13163, Thermal conductivity $\lambda_D = 0.034$ W/mK Standard EN 12667, with Compressive strength ≥ 150 kPa, compliant with **Minimum Environmental Criteria (CAM - Criteri Ambientali Minimi)**

Intended use

- Thermal insulation in skirting of external thermal insulation composite systems

CHARACTERISTICS	VALUES
Class	150
Declared thermal conductivity λ_D at 10°C (W/mK) - EN 12667	0.034
Reaction to fire - EN 13501-1	Euroclass E
Compressive strength (kPa) - EN 826	≥ 150
Thickness mm	60÷240
Length mm	1000
Width mm	500
Moulded edges	
Intended use	

Code	Dimensions mm	Panels in Pack	Avail. in days
156695	60x500x1000	10	on request
156710	80x500x1000	7	on request
156731	100x500x1000	6	on request
156732	120x500x1000	5	on request
156751	140x500x1000	4	on request
156733	160x500x1000	3	on request
156736	180x500x1000	3	on request
156737	200x500x1000	3	on request
156753	220x500x1000	2	on request
156738	240x500x1000	2	on request

DESIGNATION CODE PURSUANT TO UNI EN 13163

Panels 500x1000 mm: EPS-EN 13163-T1-L2-W2-S2-P3-DS(N)2-DS(70,-)1-CS(10/Y)150-TR200-WL(P)0,5-MU(30-70)

DOCUMENTS AVAILABLE ON WEBSITE www.soprema.it

General Catalogue

Price List

Declaration of Performance DOP - CE Marking

Technical Data Sheet TDS

Declaration of Conformity to Minimum Environmental Requirements CAM

Safety Data Sheet VSDS



Compliant with Minimum Environmental Criteria CAM

Neostir 029 150 ECO



Insulation panels in moulded expanded polystyrene EPS additivated with graphite.



Insulation panels in grey moulded expanded polystyrene EPS additivated with graphite, with CE marking compliant with Standard UNI EN 13163, with Thermal conductivity $\lambda_D = 0.029$ W/mK Standard EN 12667, with Compressive strength ≥ 150 kPa, compliant with **Minimum Environmental Criteria (CAM - Criteri Ambientali Minimi)**

Intended use

- Thermal insulation of flat warm roofs with waterproofing with PVC-TPO synthetic membranes

CHARACTERISTICS	VALUES
Class	150
Declared thermal conductivity λ_D at 10°C (W/mK) - EN 12667	0.029
Compressive strength (kPa) - EN 826	≥ 150
Reaction to fire - EN 13501-1	Euroclass E
Thickness mm	40÷300
Length mm	1200
Width mm	1200
Moulded edges	
Intended use	

Panels available with slope 1 - 1.5 - 2% only with moulded and sharp edges.

On request, possibility to supply panels with perimeter rebate.

Code	Dimensions mm	Panels in Pack	Avail. in days
110421	40x1200x1200	12	on request
109124	60x1200x1200	8	on request
109125	80x1200x1200	6	on request
109126	100x1200x1200	5	on request
109127	120x1200x1200	4	on request
109128	140x1200x1200	4	on request
109129	160x1200x1200	3	on request
109130	180x1200x1200	2	on request
109131	200x1200x1200	2	on request
109734	220x1200x1200	2	on request
109736	240x1200x1200	2	on request
109737	260x1200x1200	2	on request
109738	280x1200x1200	2	on request
109739	300x1200x1200	2	on request
109132	20÷38 x1200x1200 slope 1.5%	18	on request
109133	38÷56 x1200x1200 slope 1.5%	10	on request
109134	56÷74 x1200x1200 slope 1.5%	8	on request
109135	74÷92 x1200x1200 slope 1.5%	6	on request
114374	92÷110 x1200x1200 slope 1.5%	4	on request
109137	110÷128 x1200x1200 slope 1.5%	4	on request

DESIGNATION CODE PURSUANT TO UNI EN 13163

Panels 500x1000 mm: EPS-EN 13163-L2-W2-T1-S2-P3-DS200-CS(10/Y)150-WL(P)0,5-MU(30÷70)-DS(N)2-DS(70,-)1

DOCUMENTS AVAILABLE ON WEBSITE www.soprema.it

General Catalogue

Price List

Declaration of Performance DOP - CE Marking

Technical Data Sheet TDS

Declaration of Conformity to Minimum Environmental Requirements CAM

Safety Data Sheet VSDS



Compliant with Minimum Environmental Criteria CAM

Neostir 029 200 ECO



Insulation panels in moulded expanded polystyrene EPS additivated with graphite.



Insulation panels in grey moulded expanded polystyrene EPS additivated with graphite, with CE marking compliant with Standard UNI EN 13163, with Thermal conductivity $\lambda_D = 0.029$ W/mK Standard EN 12667, with Compressive strength ≥ 200 kPa, compliant with **Minimum Environmental Criteria (CAM - Criteri Ambientali Minimi)**

Intended use

- Thermal insulation of flat warm roofs with waterproofing with synthetic membranes in PVC/TPO

CHARACTERISTICS	VALUES
Class	200
Declared thermal conductivity λ_D at 10°C (W/mK) - EN 12667	0.029
Compressive strength (kPa) - EN 826	≥ 200
Reaction to fire - EN 13501-1	Euroclass E
Thickness mm	40÷300
Length mm	1200
Width mm	1200
Moulded edges	
Intended use	

Panels available with slope 1 - 1.5 - 2% only with moulded and sharp edges.

On request, possibility to supply panels with perimeter rebate

Code	Dimensions mm	Panels in Pack	Avail. in days
159029	40x1200x1200	12	on request
152283	60x1200x1200	8	on request
152284	80x1200x1200	6	on request
152285	100x1200x1200	5	on request
152286	120x1200x1200	4	on request
152287	140x1200x1200	4	on request
152288	160x1200x1200	3	on request
159996	180x1200x1200	2	on request
159997	200x1200x1200	2	on request
159998	220x1200x1200	2	on request
159999	240x1200x1200	2	on request
160000	260x1200x1200	2	on request
160001	280x1200x1200	2	on request
160002	300x1200x1200	2	on request
159310	20÷38 x1200x1200 slope 1.5%	18	on request
159311	38÷56 x1200x1200 slope 1.5%	10	on request
159312	56÷74 x1200x1200 slope 1.5%	8	on request
159313	74÷92 x1200x1200 slope 1.5%	6	on request
159314	92÷110 x1200x1200 slope 1.5%	4	on request
159315	110÷128 x1200x1200 slope 1.5%	4	on request

DESIGNATION CODE PURSUANT TO UNI EN 13163

Panels 500x1000 mm: EPS-EN 13163-L2-W2-T1-S2-P3-DS250-CS(10/Y)200-WL(P)0,5-MU(40÷100)-DS(N)2-DS(-)1

DOCUMENTS AVAILABLE ON WEBSITE www.soprema.it

General Catalogue

Price List

Declaration of Performance DOP - CE Marking

Technical Data Sheet TDS

Declaration of Conformity to Minimum Environmental Requirements CAM

Safety Data Sheet VSDS

Sirapor 034 150



Insulation panels in moulded expanded polystyrene EPS.



Insulation panels in moulded expanded polystyrene EPS, with CE marking compliant with Standard UNI EN 13163, with Thermal conductivity $\lambda_D = 0.034$ W/mK Standard EN 12667, Compressive strength ≥ 150 kPa Standard EN 826.

Intended use

- Thermal insulation of flat warm roofs with waterproofing with synthetic membranes in PVC/TPO

CHARACTERISTICS	VALUES
Class	150
Declared thermal conductivity λ_D at 10°C (W/mK) - EN 12667	0.034
Compressive strength (kPa) - EN 826	≥ 150
Reaction to fire - EN 13501-1	Euroclass E
Thickness mm	40÷300
Length mm	1200
Width mm	1200
Moulded edges	
Intended use	

Code	Dimensions mm	Panels in Pack	Avail. in days
110503	40x1200x1200	12	on request
109096	60x1200x1200	8	on request
109097	80x1200x1200	6	on request
109098	100x1200x1200	5	on request
109099	120x1200x1200	4	on request
111795	140x1200x1200	4	on request
109101	160x1200x1200	3	on request
109102	180x1200x1200	2	on request
109103	200x1200x1200	2	on request
109729	220x1200x1200	2	on request
109730	240x1200x1200	2	on request
109731	260x1200x1200	2	on request
109732	280x1200x1200	2	on request
109733	300x1200x1200	2	on request
109104	20÷38 x1200x1200 slope 1.5%	18	on request
109105	38÷56 x1200x1200 slope 1.5%	10	on request
109106	56÷74 x1200x1200 slope 1.5%	8	on request
109107	74÷92 x1200x1200 slope 1.5%	6	on request
109108	92÷110 x1200x1200 slope 1.5%	4	on request
109109	110÷128 x1200x1200 slope 1.5%	4	on request

DESIGNATION CODE PURSUANT TO UNI EN 13163

Panels 500x1000 mm: EPS-EN 13163-L2-W2-T1-S2-P3-DS170-CS(10/Y)150-WL(P)0,5-MU(30÷70)-DS(N)2-DS(70,-)1

DOCUMENTS AVAILABLE ON WEBSITE www.soprema.it

General Catalogue

Price List

Declaration of Performance DOP - CE Marking

Technical Data Sheet TDS

Declaration of Conformity to Minimum Environmental Requirements CAM

Safety Data Sheet VSDS

Panels available with slope 1 - 1.5 - 2% only with moulded and sharp edges.

On request, possibility to supply panels with perimeter rebate

Sirapor 034 200



Insulation panels in moulded expanded polystyrene EPS.



Insulation panels in moulded expanded polystyrene EPS, with CE marking compliant with Standard UNI EN 13163, with Thermal conductivity $\lambda_D = 0.033$ W/mK Standard EN 12667, Compressive strength ≥ 200 kPa Standard EN 826.

Intended use

- Thermal insulation of flat warm roofs with waterproofing with synthetic membranes in PVC/TPO

CHARACTERISTICS	VALUES
Class	200
Declared thermal conductivity λ_D at 10°C (W/mK) - EN 12667	0.034
Compressive strength (kPa) - EN 826	≥ 200
Reaction to fire - EN 13501-1	Euroclass E
Thickness mm	40÷300
Length mm	1200
Width mm	1200
Moulded edges	
Intended use	

Code	Dimensions mm	Panels in Pack	Avail. in days
157366	40x1200x1200	12	on request
157371	60x1200x1200	8	on request
157372	80x1200x1200	6	on request
157373	100x1200x1200	5	on request
157416	120x1200x1200	4	on request
157420	140x1200x1200	4	on request
157417	160x1200x1200	3	on request
157418	180x1200x1200	2	on request
157419	200x1200x1200	2	on request
157428	220x1200x1200	2	on request
157429	240x1200x1200	2	on request
157430	260x1200x1200	2	on request
157431	280x1200x1200	2	on request
157432	300x1200x1200	2	on request
157447	20÷38 x1200x1200 slope 1.5%	18	on request
157448	38÷56 x1200x1200 slope 1.5%	10	on request
157449	56÷74 x1200x1200 slope 1.5%	8	on request
157450	74÷92 x1200x1200 slope 1.5%	6	on request
157452	92÷110 x1200x1200 slope 1.5%	4	on request
157451	110÷128 x1200x1200 slope 1.5%	4	on request

DESIGNATION CODE PURSUANT TO UNI EN 13163

Panels 500x1000 mm: EPS-EN 13163-L2-W2-T1-S2-P3-DS250-CS(10/Y)200-WL(P)0,5-MU(40÷100)-DS(N)2-DS(70,-)1

Panels available with slope 1 - 1.5 - 2% only with moulded and sharp edges.

On request, possibility to supply panels with perimeter rebate

DOCUMENTS AVAILABLE ON WEBSITE www.soprema.it

General Catalogue

Price List

Declaration of Performance DOP - CE Marking

Technical Data Sheet TDS

Declaration of Conformity to Minimum Environmental Requirements CAM

Safety Data Sheet VSDS

Sirapor 034 150 ECO



Insulation panels in moulded expanded polystyrene EPS.



Insulation panels in moulded expanded polystyrene EPS, with CE marking compliant with Standard UNI EN 13163, with Thermal conductivity $\lambda_D = 0.034$ W/mK Standard EN 12667, Compressive strength ≥ 150 kPa Standard EN 826, compliant with **Minimum Environmental Criteria (CAM - Criteri Ambientali Minimi)**

Intended use

- Thermal insulation of flat warm roofs with waterproofing with synthetic membranes in PVC/TPO

CHARACTERISTICS	VALUES
Class	150
Declared thermal conductivity λ_D at 10°C (W/mK) - EN 12667	0.034
Compressive strength (kPa) - EN 826	≥ 150
Reaction to fire - EN 13501-1	Euroclass E
Thickness mm	40÷300
Length mm	1200
Width mm	1200
Moulded edges	
Intended use	

Code	Dimensions mm	Panels in Pack	Avail. in days
160006	40x1200x1200	12	on request
160005	60x1200x1200	8	on request
160007	80x1200x1200	6	on request
160013	100x1200x1200	5	on request
160016	120x1200x1200	4	on request
160017	140x1200x1200	4	on request
160018	160x1200x1200	3	on request
160019	180x1200x1200	2	on request
160020	200x1200x1200	2	on request
160021	220x1200x1200	2	on request
160022	240x1200x1200	2	on request
160023	260x1200x1200	2	on request
160024	280x1200x1200	2	on request
160025	300x1200x1200	2	on request
159856	20÷38 x1200x1200 slope 1.5%	18	on request
159854	38÷56 x1200x1200 slope 1.5%	10	on request
159857	56÷74 x1200x1200 slope 1.5%	8	on request
159855	74÷92 x1200x1200 slope 1.5%	6	on request
159881	92÷110 x1200x1200 slope 1.5%	4	on request
159885	110÷128 x1200x1200 slope 1.5%	4	on request

DESIGNATION CODE PURSUANT TO UNI EN 13163

Panels 500x1000 mm: EPS-EN 13163-L2-W2-T1-S2-P3-DS170-CS(10/Y)150-WL(P)0,5-MU(30÷70)-DS(N)2-DS(70,-)1

DOCUMENTS AVAILABLE ON WEBSITE www.soprema.it

General Catalogue

Price List

Declaration of Performance DOP - CE Marking

Technical Data Sheet TDS

Declaration of Conformity to Minimum Environmental Requirements CAM

Safety Data Sheet VSDS



Compliant with Minimum Environmental Criteria CAM

Sirapor 034 200 ECO

Insulation panels in moulded expanded polystyrene EPS.



Insulation panels in moulded expanded polystyrene EPS, with CE marking compliant with Standard UNI EN 13163, with Thermal conductivity $\lambda_D = 0.033$ W/mK Standard EN 12667, Compressive strength ≥ 200 kPa Standard EN 826, compliant with **Minimum Environmental Criteria (CAM - Criteri Ambientali Minimi)**

Intended use

- Thermal insulation of flat warm roofs with waterproofing with synthetic membranes in PVC/TPO

CHARACTERISTICS	VALUES
Class	200
Declared thermal conductivity λ_D at 10°C (W/mK) - EN 12667	0.034
Compressive strength (kPa) - EN 826	≥ 200
Reaction to fire - EN 13501-1	Euroclass E
Thickness mm	40÷300
Length mm	1200
Width mm	1200
Moulded edges	
Intended use	

Code	Dimensions mm	Panels in Pack	Avail. in days
160006	40x1200x1200	12	on request
160005	60x1200x1200	8	on request
160007	80x1200x1200	6	on request
160013	100x1200x1200	5	on request
160016	120x1200x1200	4	on request
160017	140x1200x1200	4	on request
160018	160x1200x1200	3	on request
160019	180x1200x1200	2	on request
160020	200x1200x1200	2	on request
160021	220x1200x1200	2	on request
160022	240x1200x1200	2	on request
160023	260x1200x1200	2	on request
160024	280x1200x1200	2	on request
160025	300x1200x1200	2	on request
159856	20÷38 x1200x1200 slope 1.5%	18	on request
159854	38÷56 x1200x1200 slope 1.5%	10	on request
159857	56÷74 x1200x1200 slope 1.5%	8	on request
159855	74÷92 x1200x1200 slope 1.5%	6	on request
159881	92÷110 x1200x1200 slope 1.5%	4	on request
159885	110÷128 x1200x1200 slope 1.5%	4	on request

DESIGNATION CODE PURSUANT TO UNI EN 13163

Panels 500x1000 mm: EPS-EN 13163-L2-W2-T1-S2-P3-DS250-CS(10/Y)200-WL(P)0,5-MU(40÷100)-DS(N)2-DS(70,-)1

DOCUMENTS AVAILABLE ON WEBSITE www.soprema.it

General Catalogue

Price List

Declaration of Performance DOP - CE Marking

Technical Data Sheet TDS

Declaration of Conformity to Minimum Environmental Requirements CAM

Safety Data Sheet VSDS



Compliant with Minimum Environmental Criteria CAM

Efyos PU B

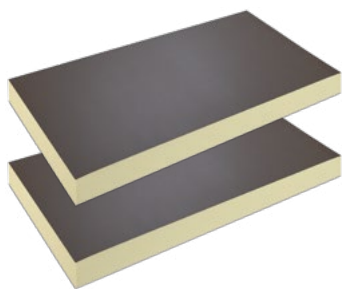

Polyurethane insulation panels



Polyurethane insulation panels free of HCFCs and HFCs with CE marking compliant with UNI EN 13165, coated on the top side in bitumen glass fibre, and on the bottom side with mineral glass fibre, compliant with **Minimum Environmental Criteria (CAM - Criteri Ambientali Minimi)**

Intended use

- Thermal insulation of flat warm roofs with waterproofing in polymer modified bitumen membranes

CHARACTERISTICS	VALUES
Declared thermal conductivity λ_D at 10°C (W/mK) - EN 12667	0.026 30÷100 0.025 120÷160
Compressive strength (kPa) - EN 826	150
Reaction to fire - EN 13501-1	Euroclass F
Type of coating	bitumen and mineral glass fibre
Thickness mm	30÷160
Length x Width mm	1200 x 600
Moulded edges	
Intended use	

Code	Dimensions mm	Panels in Pack	m ² /panel	packs/pallet	m ² /pack	m ² /pallet	Avail. in days
109834	30x600x1200	16	0.72	10	11.52	115.20	on request
109835	40x600x1200	12	0.72	10	8.64	86.40	on request
109836	50x600x1200	10	0.72	10	7.20	72.00	on request
109837	60x600x1200	8	0.72	10	5.76	57.60	on request
109839	80x600x1200	6	0.72	10	4.32	43.20	on request
109840	100x600x1200	5	0.72	10	3.60	36.00	on request
109841	120x600x1200	4	0.72	10	2.88	28.80	on request
107072	140x600x1200	3	0.72	12	2.16	25.92	on request
105902	160x600x1200	3	0.72	10	2.16	21.60	on request

DESIGNATION CODE PURSUANT TO UNI EN 13163

PU-EN 13165-T2-CS(10/Y)150-TR70-DS(70,90)2-DS(-20,-)1-WS(P)0,2-MU(60)

DOCUMENTS AVAILABLE ON WEBSITE www.soprema.it

General Catalogue

Price List

Declaration of Performance DOP - CE Marking

Technical Data Sheet TDS

Declaration of Conformity to Minimum Environmental Requirements CAM

Safety Data Sheet VSDS



Compliant with Minimum Environmental Criteria CAM

Efigreen Duo+

Polyurethane PIR insulation panels.

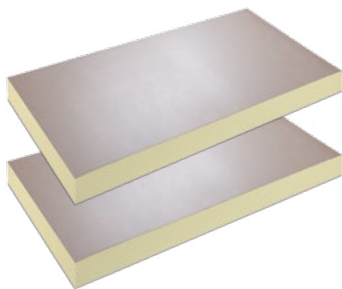

Polyurethane PIR insulation panels free of HCFCs and HFCs with CE marking, compliant with Standard UNI EN 13165, with two-sided multilayer coating, with Environmental Product Declaration EPD, compliant with **Minimum Environmental Criteria (CAM - Criteri Ambientali Minimi)**

Intended use

► Thermal insulation for ballasted roofs, walls, and interspaces

CHARACTERISTICS	VALUES
Declared thermal conductivity λ_D at 10°C (W/mK) - EN 12667	0.023 30 0.022 40÷160
Compressive strength (kPa) - EN 826	200
Reaction to fire - EN 13501-1	Euroclass F
Type of coating	two-sided multilayered
Thickness mm	30÷160
Length x Width mm	1200 x 600
Moulded edges	
Intended use	

Code	Dimensions mm	Panels in Pack	m ² /panel	packs/pallet	m ² /pack	m ² /pallet	Avail. in days
104801	30x600x1200	16	0.72	10	11.52	115.20	on request
104750	40x600x1200	12	0.72	10	8.64	86.40	on request
104751	50x600x1200	10	0.72	10	7.20	72.00	on request
104752	60x600x1200	8	0.72	10	5.76	57.60	on request
107895	70x600x1200	7	0.72	10	5.04	50.40	on request
104753	80x600x1200	6	0.72	10	4.32	43.20	on request
104802	100x600x1200	5	0.72	10	3.60	36.00	on request
105007	120x600x1200	4	0.72	10	2.88	28.80	on request
105009	140x600x1200	3	0.72	12	2.16	25.90	on request
105010	160x600x1200	3	0.72	10	2.16	21.60	on request

DESIGNATION CODE PURSUANT TO UNI EN 13163

PU-EN 13165-T2-CS(10/Y)200-WS(P)0,2

DOCUMENTS AVAILABLE ON WEBSITE www.soprema.it

General Catalogue

Price List

Declaration of Performance DOP - CE Marking

Technical Data Sheet TDS

Declaration of Conformity to Minimum Environmental Requirements CAM

Environmental Product Declaration EPD

Safety Data Sheet VSDS



Compliant with Minimum Environmental Criteria CAM

Efigreen Acier

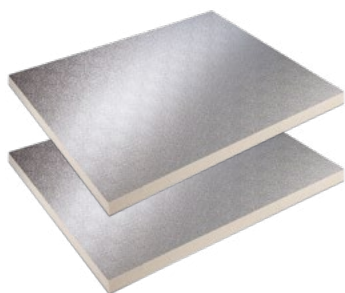

Polyurethane PIR insulation panels.



Polyurethane PIR insulation panels free of HCFCs and HFCs with CE marking, compliant with Standard UNI EN 13165, with two-sided 50 µm embossed aluminium coating, with Environmental Product Declaration EPD, compliant with **Minimum Environmental Criteria (CAM - Criteri Ambientali Minimi)**

Intended use

- Thermal insulation of warm flat roofs on sheet metal structure corrugated sheet metal or concrete with synthetic waterproofing in PVC - TPO

CHARACTERISTICS	VALUES
Declared thermal conductivity λ_D at 10°C (W/mK) - EN 12667	0.023
Compressive strength (kPa) - EN 826	150
Reaction to fire - EN 13501-1	Euroclass D-s2,d0
Type of coating	two-sided embossed aluminium
Thickness mm	30÷160
Length x Width mm	2500 x 1200
Moulded edges	
Intended use	

Code	Dimensions mm	Panels in Pack	m ² /panel	m ² /pallet	Avail. in days
017497	30x1200x2500	40	3	120	on request
017495	40x1200x2500	30	3	90	on request
017496	50x1200x2500	24	3	72	on request
017498	60x1200x2500	20	3	60	on request
017499	70x1200x2500	17	3	51	on request
017500	80x1200x2500	15	3	45	on request
017501	90x1200x2500	13	3	39	on request
017502	100x1200x2500	12	3	36	on request
104579	120x1200x2500	10	3	30	on request

Thickness 140-160 mm: on request

DESIGNATION CODE PURSUANT TO UNI EN 13163

PU-EN 13165-T2-CS(10/Y)150-WS(P)0,2

DOCUMENTS AVAILABLE ON WEBSITE www.soprema.it

General Catalogue

Price List

Declaration of Performance DOP - CE Marking

Technical Data Sheet TDS

Declaration of Conformity to Minimum Environmental Requirements CAM

Environmental Product Declaration EPD

Safety Data Sheet VSDS



Compliant with Minimum Environmental Criteria CAM

Efigreen Alu+

Polyurethane PIR insulation panels.



Polyurethane PIR insulation panels free of HCFCs and HFCs with CE marking, compliant with Standard UNI EN 13165, with two-sided multilayer coating, with Environmental Product Declaration EPD, compliant with **Minimum Environmental Criteria (CAM - Criteri Ambientali Minimi)**

Intended use

- Thermal insulation of flat warm roofs, waterproofed with polymer modified bitumen membranes and self-adhesive or mechanically fixed PVC and TPO synthetic membranes.

CHARACTERISTICS	VALUES
Declared thermal conductivity λ_D at 10°C (W/mK) - EN 12667	0.023 30 0.022 40÷160
Compressive strength (kPa) - EN 826	200
Reaction to fire - EN 13501-1	Euroclass F
Type of coating	two-sided multilayered
Thickness mm	30÷140
Length x Width mm	1200 x 600
Moulded edges	
Intended use	

Code	Dimensions mm	Panels in Pack	m ² /panel	packs/pallet	m ² /pack	m ² /pallet	Avail. in days
105921	30x600x1200	16	0.72	10	11.52	115.20	on request
105922	40x600x1200	12	0.72	10	8.64	86.40	on request
105924	50x600x1200	10	0.72	10	7.20	72.00	on request
105925	60x600x1200	8	0.72	10	5.76	57.60	on request
105937	70x600x1200	7	0.72	10	5.04	50.40	on request
105926	80x600x1200	6	0.72	10	4.32	43.20	on request
105927	90x600x1200	5	0.72	10	3.60	36.00	on request
105928	100x600x1200	5	0.72	10	3.60	36.00	on request
105930	120x600x1200	4	0.72	10	2.88	28.80	on request
105932	140x600x1200	3	0.72	12	2.16	25.92	on request

DESIGNATION CODE PURSUANT TO UNI EN 13163

PU-EN 13165-T2-CS(10/Y)200-TR150-WS(P)0,2

DOCUMENTS AVAILABLE ON WEBSITE www.soprema.it

General Catalogue

Price List

Declaration of Performance DOP - CE Marking

Technical Data Sheet TDS

Declaration of Conformity to Minimum Environmental Requirements CAM

Environmental Product Declaration EPD

Safety Data Sheet VSDS



Compliant with Minimum Environmental Criteria CAM

Stirodach

Insulation panels in extruded polystyrene foam with metal profile.



Thermal insulation panel in extruded polystyrene foam XPS with low-emissivity embossed aluminium membrane coating on the extrados, with metal tile support compliant with **Minimum Environmental Criteria (CAM - Criteri Ambientali Minimi)**

Intended use

Moulded edges:



► Thermal insulation and ventilation under shingles and bent tiles on pitched roofs

CHARACTERISTICS	VALUES
Declared thermal conductivity λ_D at 10°C (W/mK) - EN 12667	0.032 mm 50-60 0.034 mm 80-100 120-140
Thickness mm	50 - 60 - 80- 100- 120- 140
Length mm	3000
Pitch mm	320-325-330-335 340-342-345-350 355-360-365-370
Intended use	

Code	Dimensions mm	Panels in Pack	m ² /Pack	Packs/pallet	m ² /pallet	Avail. in days
112874	50x320x3000	6	5.76	21	120.96	on request
113449	50x325x3000	6	5.85	21	122.85	on request
113451	50x330x3000	6	5.94	21	124.74	on request
113452	50x335x3000	6	6.03	21	126.63	on request
113453	50x340x3000	6	6.12	21	128.52	on request
112875	50x342x3000	6	6.16	21	129.36	on request
112179	50x345x3000	6	6.21	21	130.41	on request
113454	50x350x3000	6	6.30	21	132.30	on request
113455	50x355x3000	6	6.39	21+14*	223.65	on request
113456	50x360x3000	6	6.48	21+14*	226.80	on request
113457	50x365x3000	6	6.57	21+14*	229.95	on request
115475	50x370x3000	6	6.66	21+14*	233.10	on request
112876	60x320x3000	6	5.76	18	103.68	on request
113460	60x325x3000	6	5.85	18	105.30	on request
112877	60x330x3000	6	5.94	18	106.92	on request
113461	60x335x3000	6	6.03	18	108.54	on request
112878	60x340x3000	6	6.12	18	110.16	on request
112879	60x342x3000	6	6.16	18	110.88	on request
112180	60x345x3000	6	6.21	18	111.78	on request
113462	60x350x3000	6	6.30	18	113.40	on request
113464	60x355x3000	6	6.39	18+12*	191.70	on request
113465	60x360x3000	6	6.48	18+12*	194.40	on request
113466	60x365x3000	6	6.57	18+12*	197.10	on request
113467	60x370x3000	6	6.66	18+12*	199.80	on request

* First and second full pallet combined. Other pitches: as needed for minimum orders of more than 200 m².

Stirodach

Insulation panels in extruded polystyrene foam with metal profile.



Thermal insulation panel in extruded polystyrene foam XPS with low-emissivity embossed aluminium membrane coating on the extrados, with metal tile support compliant with **Minimum Environmental Criteria (CAM - Criteri Ambientali Minimi)**

Moulded edges:



Code	Dimensions mm	Panels in Pack	m ² /Pack	Packs/pallet	m ² /pallet	Avail. in days
113608	80x320x3000	4	3.84	21	80.64	on request
112880	80x325x3000	4	3.90	21	81.90	on request
112881	80x330x3000	4	3.96	21	83.16	on request
112882	80x335x3000	4	4.02	21	84.42	on request
112883	80x340x3000	4	4.08	21	85.68	on request
112884	80x342x3000	4	4.10	21	86.10	on request
112885	80x345x3000	4	4.14	21	86.94	on request
112886	80x350x3000	4	4.20	21	88.20	on request
113472	80x355x3000	4	4.26	21+14*	149.10	on request
113473	80x360x3000	4	4.32	21+14*	151.20	on request
113474	80x365x3000	4	4.38	21+14*	153.30	on request
113475	80x370x3000	4	4.44	21+14*	155.40	on request
112887	100x320x3000	4	3.84	18	69.12	on request
112888	100x325x3000	4	3.90	18	70.20	on request
112889	100x330x3000	4	3.96	18	71.28	on request
113476	100x335x3000	4	4.02	18	72.36	on request
112890	100x340x3000	4	4.08	18	73.44	on request
112891	100x342x3000	4	4.10	18	73.87	on request
112892	100x345x3000	4	4.14	18	74.52	on request
112893	100x350x3000	4	4.20	18	75.60	on request
113477	100x355x3000	4	4.26	18+12*	127.80	on request
113478	100x360x3000	4	4.32	18+12*	129.60	on request
113479	100x365x3000	4	4.38	18+12*	131.40	on request
113480	100x370x3000	4	4.44	18+12*	133.20	on request

* First and second full pallet combined. Other pitches: as needed for minimum orders of more than 200 m².

Stirodach

Insulation panels in extruded polystyrene foam with metal profile.



Thermal insulation panel in extruded polystyrene foam XPS with low-emissivity embossed aluminium membrane coating on the extrados, with metal tile support compliant with **Minimum Environmental Criteria (CAM - Criteri Ambientali Minimi)**

Moulded edges:



Code	Dimensions mm	Panels in Pack	m ² /Pack	Packs/pallet	m ² /pallet	Avail. in days
113481	120x320x3000	3	2.88	18	51.84	on request
115251	120x325x3000	3	2.93	18	52.74	on request
112894	120x330x3000	3	2.97	18	53.46	on request
114804	120x335x3000	3	3.02	18	54.36	on request
113484	120x340x3000	3	3.06	18	55.08	on request
115519	120x342x3000	3	3.08	18	55.44	on request
112896	120x345x3000	3	3.11	18	55.98	on request
113485	120x350x3000	3	3.15	18	56.70	on request
113486	120x355x3000	3	3.20	18+12*	96.00	on request
113487	120x360x3000	3	3.24	18+12*	97.20	on request
113488	120x365x3000	3	3.29	18+12*	98.55	on request
113489	120x370x3000	3	3.33	18+12*	99.90	on request
114784	140x320x3000	3	2.88	18	51.84	on request
113491	140x325x3000	3	2.93	18	52.74	on request
112897	140x330x3000	3	2.97	18	53.46	on request
115141	140x335x3000	3	3.02	18	54.36	on request
113493	140x340x3000	3	3.06	18	55.08	on request
112898	140x342x3000	3	3.08	18	55.44	on request
114848	140x345x3000	3	3.11	18	55.98	on request
113495	140x350x3000	3	3.15	18	56.70	on request
113496	140x355x3000	3	3.20	18+12*	96.00	on request
113497	140x360x3000	3	3.24	18+12*	97.20	on request
113498	140x365x3000	3	3.29	18+12*	98.70	on request
113499	140x370x3000	3	3.33	18+12*	99.90	on request

* First and second full pallet combined. Other pitches: as needed for minimum orders of more than 200 m².

Stirodach Gronda

Code	Dimensions mm	Panels in Pack	m ² /Pack	Packs/pallet	m ² /pallet	Avail. in days
113500	50x290x3000	6	5.22	-	-	on request
113501	60x290x3000	6	5.22	-	-	on request
113502	80x290x3000	4	3.48	-	-	on request
113503	100x290x3000	4	3.48	-	-	on request
112504	120x290x3000	3	2.61	-	-	on request
113505	140x290x3000	3	2.61	-	-	on request



Styrholz H

Thermal insulation panels in cement-bonded wood fibre.



Panels in mineralised wood fibre, bonded with high-resistance grey cement, compliant with Standard UNI EN 13168, with CE marking.

Intended use

- Additional layer in roofs to increase the surface mass

CHARACTERISTICS	Styrholz H 15	Styrholz H 25	Styrholz H 35	Styrholz H 50	Styrholz H 75
Dimensions mm	2000 x 600 x 15	2000 x 600 x 25	2000 x 600 x 35	2000 x 600 x 50	2000 x 600 x 75
Surface mass Kg/m ²	8.5	11.5	14.5	19.5	28
Heat resistance R _g m ² K/W	0.20	0.35	0.55	0.75	1.15
Intended use					

Code	Dimensions mm	Panels/pallet	m ² /pallet	Avail. in days
114075	15x600x2000	110	132	on request
114126	25x600x2000	80	96	on request
110565	35x600x2000	60	72	on request
114133	50x600x2000	40	48	on request
114137	75x600x2000	28	33.6	on request

Velaphone

Acoustic insulation for subfloors.

Rolls comprised of a layer of polyester fibre bonded to a bituminous support, with self-adhesive longitudinal selvedge.

Intended use

- Impact acoustic insulation for subfloors



CHARACTERISTICS	Values
Sound reduction index ΔL_w (dB)	24
Dimensions	Thickness 3.3 mm - Length 20 m - Width 1 m
Weight of roll kg	13

Code	Dimensions	m ² /roll	Rolls pallet	m ² /full pallet	Roll weight kg	Avail. in days
033841	Length 20 m Width 1 m Thickness 3.3 mm	20	16	320	approx. 13	on request

Thermal and Acoustic Insulation - Accessories



Aluband

Adhesive joint tape

Code	Pack
112948	Cardboard boxes of 8 rolls each 10 m long and 75 mm wide Theoretical yield: 0.6 lm/m ²



Dachroll

Ridge tape in rolls

Code	Pack
221039	Cardboard boxes of 4 rolls each 5 m long and 40 cm wide Theoretical yield: 1lm/1lm of ridge



Clips

Ridge clips

Code	Pack
221028	Cardboard boxes of 50 pieces Theoretical yield: 1pc/1 ridge element



CV Brackets

Ridge batten brackets

Code	Pack
221029	Loose - section 40x1.2 mm - height 25 cm Theoretical yield: 1pc/1lm of ridge



Coverdach Alu

Waterproofing junction for roof elements

Code	Pack
117951	2 rolls per pack

Thermal and Acoustic Insulation - Accessories



Bird screens

Code	Pack
221035	Cardboard boxes of 150 pieces each 1 m long Theoretical yield: 1m/11m of eaves



Dowels

For panel fixing

Code	Pack	Pack
221030	Dowel 10/100	Box of 100 pieces
221196	Dowel 10/160	Box of 50 pieces



Alsan Foam UNI

Foam sealant to fill interspaces

Code	Pack
153058	Cardboard boxes of 12 spray cans 750 ml/ea.



Alsan Sil 2440 FA

Single component elastic joint sealant

Code	Pack
152424	Cardboard boxes of 12 cartridges each 300 ml Theoretical yield: 1 cartridge / 10 m ²



Professional Waterproofing Membranes



Technical reference standards

UNI 8818: Sheets for roofing and sealing
Classification based on product description
Waterproofing mass composition acronyms:
- BPE Elastomeric Polymer Bitumen
- BPP Plastomeric Polymer Bitumen

UNI EN 13707: Flexible sheets for waterproofing -
Reinforced bitumen sheets for roof waterproofing

UNI EN 13969: Flexible sheets for waterproofing
- Bitumen damp proof sheets including bitumen
basement tanking sheets

UNI EN 13859-1: Flexible sheets for waterproofing -
Definitions and characteristics of underlays - Part 1:
Underlays for discontinuous roofing

UNI EN 13970: Flexible sheets for waterproofing -
Bitumen water vapour control layers

UNI EN 14695: Flexible sheets for waterproofing
- Reinforced bitumen sheets for waterproofing of
concrete bridge decks and other trafficked areas of
concrete

UNI EN 13948: Flexible sheets for waterproofing
- Bitumen, plastic and rubber sheets for roof
waterproofing - Determination of resistance to root
penetration

UNI EN 13583: Flexible sheets for waterproofing
- Bitumen, plastic and rubber sheets for roof
waterproofing - Determination of hail resistance

UNI CEN/TS 1187: Test methods for external fire
exposure to roofs

UNI EN 13501-5: Fire classification of construction
products and building elements - Part 5:
Classification using data from external fire exposure
to roofs tests

Polymer Modified Bitumen Membranes

The range of Novaglass-branded professional bitumen membranes includes products with a waterproofing mass composition classified as BPP (Plastomeric Polymer Bitumen) and BPE (Elastomeric Polymer Bitumen) in accordance with Standard UNI 8818.

BPP membranes, also known as elastoplastomeric membranes, are comprised of a waterproofing mass in distilled bitumen modified with polyolefin polymers (APP) and composite internal reinforcements in non-woven continuous filament geotextile, stabilised with glass fibre or glass mesh. They are characterised by high resistance to UV rays.



















BPE membranes, also known as elastomeric membranes, are comprised of a waterproofing mass in distilled bitumen modified with thermoplastic elastomers (SBS) and composite internal reinforcements in non-woven continuous filament geotextile, stabilised with glass fibre or glass mesh. They are characterised by their excellent cold flexibility.

Alongside traditional torch-applied membranes, Soprema offers high-performance self-adhesive membranes.

Characterised by their excellent cold flexibility, they represent a valid response to the need for safety in construction sites, fast installation, and versatility of use typical of new building technologies.

All polymer modified bitumen membranes can be supplied with different types of surface finishes.

Key for intended uses

	Damp proof course		Cool Roof		Vapour Barrier
	Elastic Joints		Concrete bridge decks		Under heavy ballast
	Visible single layer on bituminous adhesive		Single layer for refurbishments		Multi-layer systems
	Underground elements		Fire resistance		Hail resistance
	Anti-root		Anti Radon		Underlays and middle layers
	Underlays for discontinuous roofing		Car park roofs		Single layer under hot laid asphalt

Novagum-P/Novagum-P Mineral

BPE -25 °C



Bitumen membrane with waterproofing mass classified as BPE (Elastomeric Polymer Bitumen) in accordance with standard UNI 8818, comprised of distilled bitumen modified with thermoplastic elastomers (SBS) and composite internal reinforcement in non-woven heavy weight continuous filament polyester geotextile stabilised with glass fibre. Product with CE marking compliant with standards EN 13707, EN 13969, EN 13970, EN 13859-1. Cold flexibility: $\leq -25\text{ °C}$ (EN 1109). In the MINERAL version, the top side has a self-protective finish with natural or coloured ceramic slate chips.

Dark Grey



Standard colour

Green*





Red*



White*

 * Available on request, minimum order 2,000 m²

CHARACTERISTICS	Novagum P 4 mm	Novagum P 5 mm	Novagum P Mineral 4.5 Kg	Novagum P Mineral 4 mm (thickness on selvedge)
Dimensions m	1 x 10	1 x 7.5	1 x 10	1 x 7.5
Rolls per pallet - m ²	20 - 200	20 - 150	20 - 200	23 - 172.5
Top side finish	Anti-adhesive sand	Anti-adhesive sand	Slate chips	Slate chips
Bottom side finish	PP film	PP film	PP film	PP film
Intended use				

Flexgum-P/Flexgum-P Mineral Flexgum-P DIA

BPE -20 °C



Bitumen membrane with waterproofing mass classified as BPE (Elastomeric Polymer Bitumen) in accordance with standard UNI 8818, comprised of distilled bitumen modified with thermoplastic elastomers (SBS) and composite internal reinforcement in non-woven heavy weight continuous filament polyester geotextile stabilised with glass fibre. Product with CE marking compliant with standards EN 13707, EN 13969, EN 13859-1. Cold flexibility: $\leq -20\text{ °C}$ (EN 1109) In the MINERAL version, the top side has a self-protective finish with natural or coloured ceramic slate chips. In the DIA version, the top side has a self-protective finish with Black Diamond slate micro-chips.

Dark Grey



Standard colour

Green*



Red*



White*



Brown*

 * Available on request, minimum order 2,000 m²

CHARACTERISTICS	Flexgum-P 4 mm	Flexgum-P 5 mm	Flexgum-P Mineral 4.5 Kg	Flexgum-P DIA 4 mm
Dimensions m	1 x 10	1 x 7.5	1 x 10	1 x 7.5
Rolls per pallet - m ²	20 - 200	20 - 150	20 - 200	25 - 187.5
Top side finish	Anti-adhesive sand	Anti-adhesive sand	Slate chips	Black Diamond
Bottom side finish	PP film	PP film	PP film	PP film
Intended use				

Isogum-P/Isogum-P Mineral

BPE -20 °C



Bitumen membrane with waterproofing mass classified as BPE (Elastomeric Polymer Bitumen) in accordance with standard UNI 8818, comprised of distilled bitumen modified with thermoplastic elastomers (SBS) and composite internal reinforcement in non-woven continuous filament polyester geotextile stabilised with glass fibre. Product with CE marking compliant with standards EN 13707, EN 13969, EN 13970, EN 13859-1. Cold flexibility: $\leq -20\text{ °C}$ (EN 1109)

In the MINERAL version, the top side has a self-protective finish with natural or coloured ceramic slate chips.

Dark Grey



Standard colour

Green*



Red*









White*



Brown*

 * Available on request, minimum order 2,000 m²

CHARACTERISTICS	Isogum-P 4 mm	Isogum-P Mineral 4.5 Kg	Isogum-P Mineral 5 Kg
Dimensions m	1 x 10	1 x 10	1 x 10
Rolls per pallet - m ²	20 - 200	20 - 200	20 - 200
Top side finish	Anti-adhesive sand	Slate chips	Slate chips
Bottom side finish	PP film	PP film	PP film
Intended use	    	 	

Nova Isorooft Plus «S» Nova Isorooft Plus «S» Mineral

BPE -20 °C

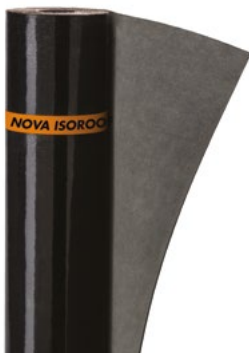

Bitumen membrane with waterproofing mass classified as BPE (Elastomeric Polymer Bitumen) in accordance with standard UNI 8818, comprised of distilled bitumen modified with thermoplastic elastomers (SBS) and composite internal reinforcement in non-woven continuous filament polyester geotextile stabilised with glass fibre. Product with CE marking compliant with standards EN 13707, EN 13969, EN 13859-1. Cold flexibility: $\leq -20\text{ °C}$ (EN 1109)

In the MINERAL version, the top side has a self-protective finish with natural or coloured ceramic slate chips.

Dark Grey



Standard colour

Green*









Red*



White*

 * Available on request, minimum order 2,000 m²

CHARACTERISTICS	Nova Isorooft Plus «S» 3 mm	Nova Isorooft Plus «S» 4 mm	Nova Isorooft Plus «S» 4 Kg	Nova Isorooft Plus «S» Mineral 4 Kg	Nova Isorooft Plus «S» Mineral 4, 5 Kg	Nova Isorooft Plus «S» Mineral 5 Kg
Dimensions m	1 x 10	1 x 10	1 x 10	1 x 10	1 x 10	1 x 10
Rolls per pallet - m ²	25 - 250	20 - 200	25 - 250	25 - 250	23 - 230	20 - 200
Top side finish	Anti-adhesive sand	Anti-adhesive sand	Anti-adhesive sand	Slate chips	Slate chips	Slate chips
Bottom side finish	PP film	PP film	PP film	PP film	PP film	PP film
Intended use	    				 	

Isorooft-SBS/Isorooft-SBS Mineral

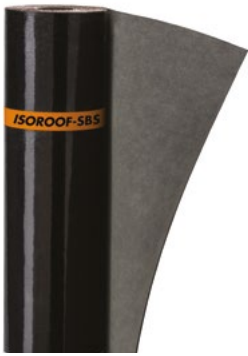
BPE -15 °C

Bitumen membrane with waterproofing mass classified as BPE (Elastomeric Polymer Bitumen) in accordance with standard UNI 8818, comprised of distilled bitumen modified with thermoplastic elastomers (SBS) and composite internal reinforcement in non-woven continuous filament polyester geotextile stabilised with glass fibre. Product with CE marking compliant with standards EN 13707, EN 13969, EN 13970, EN 13859-1.







Cold flexibility: $\leq -15 \text{ °C}$ (EN 1109)

In the MINERAL version, the top side has a self-protective finish with natural ceramic slate chips.

Dark Grey



Standard colour

CHARACTERISTICS	Isorooft-SBS 4 mm	Isorooft-SBS Mineral 4.5 Kg
Dimensions m	1 x 10	1 x 10
Rolls per pallet - m ²	20 - 200	23 - 230
Top side finish	Anti-adhesive sand	Slate chips
Bottom side finish	PP film	PP film
Intended use	    	 

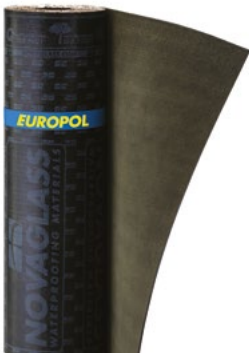

Europol/Europol Mineral

BPP -25 °C

Bitumen membrane with waterproofing mass classified as BPP (Plastomeric Polymer Bitumen) in accordance with standard UNI 8818, comprised of distilled bitumen modified with high-quality polyolefin polymers (APP) obtained through a process of polymerisation catalysed by metallocenes, and composite internal reinforcement in non-woven heavy weight continuous filament polyester geotextile stabilised with glass fibre. Product with CE marking compliant with standards EN 13707, EN 13969, EN 13859-1. Cold flexibility: ≤ -25 °C (EN 1109)

In the MINERAL version, the top side has a self-protective finish with natural or coloured ceramic slate chips.

Dark Grey



Standard colour

Green*





Red*



White*

 * Available on request, minimum order 2,000 m²

CHARACTERISTICS	Europol 4 mm	Europol Mineral 4.5 Kg	Europol Mineral 4 mm (thickness on seldge)
Dimensions m	1 x 10	1 x 10	1 x 7.5
Rolls per pallet - m ²	20 - 200	20 - 200	23 - 172.5
Top side finish	Anti-adhesive sand	Slate chips	Slate chips
Bottom side finish	Hot melt film	Hot melt film	Hot melt film
Intended use			

Novatop/Novatop Mineral

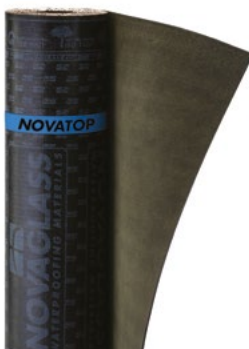
BPP -20 °C

Bitumen membrane with waterproofing mass classified as BPP (Plastomeric Polymer Bitumen) in accordance with standard UNI 8818, comprised of distilled bitumen modified with high-quality polyolefin polymers (APP) obtained through a process of polymerisation catalysed by metallocenes, and composite internal reinforcement in non-woven heavy weight continuous filament polyester geotextile stabilised with glass fibre. Product with CE marking compliant with standards EN 13707, EN 13969, EN 13859-1. Cold flexibility: ≤ -20 °C (EN 1109)

In the MINERAL version, the top side has a self-protective finish with natural or coloured ceramic slate chips.

Dark Grey



Standard colour

Reflecta*



Green*





Red*



White*

 * Available on request, minimum order 2,000 m²

CHARACTERISTICS	Novatop 4 mm	Novatop 5 mm	Novatop Mineral 4.5 Kg (not available with Reflecta finish)	Novatop Mineral 4 mm (thickness on seldge)
Dimensions m	1 x 10	1 x 7.5	1 x 10	1 x 7.5
Rolls per pallet - m ²	20 - 200	20 - 150	20 - 200	23 - 172.5
Top side finish	Anti-adhesive sand	Anti-adhesive sand	Slate chips	Slate chips
Bottom side finish	Hot melt film	Hot melt film	Hot melt film	Hot melt film
Intended use				

Novater S-C/Novater S-C Mineral

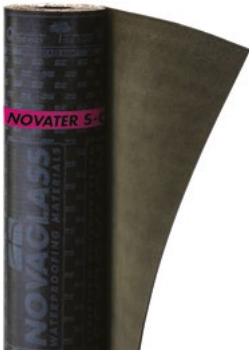
BPP -15 °C

Bitumen membrane with waterproofing mass classified as BPP (Plastomeric Polymer Bitumen) in accordance with standard UNI 8818, comprised of distilled bitumen modified with high-quality polyolefin polymers (APP) obtained through a process of polymerisation catalysed by metallocenes, and composite internal reinforcement in non-woven heavy weight continuous filament polyester geotextile stabilised with glass fibre. Product with CE marking compliant with standards EN 13707, EN 13969, EN 13859-1 Cold flexibility: $\leq -15\text{ °C}$ (EN 1109)

In the MINERAL version, the top side has a self-protective finish with natural or coloured ceramic slate chips.

Dark Grey



Standard colour

Green*



Red*





White*



Brown*



 * Available on request, minimum order 2,000 m²

CHARACTERISTICS	Novater S-C 4 mm	Novater S-C 5 mm	Novater S-C Mineral 4.5 Kg	Novater S-C Mineral 5 Kg
Dimensions m	1 x 10	1 x 7.5	1 x 10	1 x 10
Rolls per pallet - m ²	20 - 200	20 - 150	20 - 200	18 - 180
Top side finish	Anti-adhesive sand	Anti-adhesive sand	Slate chips	Slate chips
Bottom side finish	Hot melt film	Hot melt film	Hot melt film	Hot melt film
Intended use				

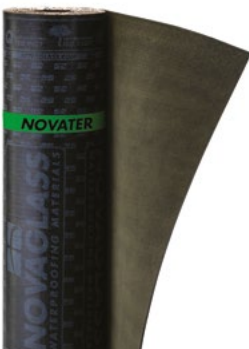
Novater

BPP -10 °C

Bitumen membrane with waterproofing mass classified as BPP (Plastomeric Polymer Bitumen) in accordance with standard UNI 8818, comprised of distilled bitumen modified with high-quality polyolefin polymers (APP) obtained through a process of polymerisation catalysed by metallocenes, and composite internal reinforcement in non-woven heavy weight continuous filament polyester geotextile stabilised with glass fibre. Product with CE marking compliant with standards EN 13707, EN 13969, EN 13859-1 Cold flexibility: $\leq -10\text{ °C}$ (EN 1109)

CHARACTERISTICS	Novater 3 mm	Novater 4 mm	Novater 5 mm
Dimensions m	1 x 10	1 x 10	1 x 7.5
Rolls per pallet - m ²	25 - 250	20 - 200	20 - 150
Top side finish	Anti-adhesive sand	Anti-adhesive sand	Anti-adhesive sand
Bottom side finish	Hot melt film	Hot melt film	Hot melt film
Intended use			

Isopol/Isopol Mineral

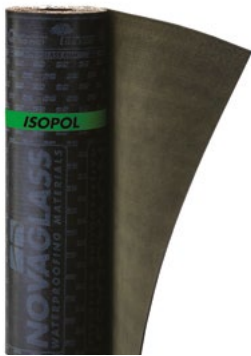
BPP -10 °C

Bitumen membrane with waterproofing mass classified as BPP (Plastomeric Polymer Bitumen) in accordance with standard UNI 8818, comprised of distilled bitumen modified with high-quality polyolefin polymers (APP) obtained through a process of polymerisation catalysed by metallocenes, and composite internal reinforcement in non-woven continuous filament polyester geotextile stabilised with glass fibre. Product with CE marking compliant with standards EN 13707, EN 13969, EN 13970, EN 13859-1



Cold flexibility: ≤ -10 °C (EN 1109)

In the MINERAL version, the top side has a self-protective finish with natural or coloured ceramic slate chips.

Dark Grey



Standard colour

CHARACTERISTICS	Isopol 3 mm	Isopol 4 mm	Isopol Mineral 4 Kg	Isopol Mineral 4.5 Kg
Dimensions m	1 x 10	1 x 10	1 x 10	1 x 10
Rolls per pallet - m ²	25 - 250	20 - 200	25 - 250	23 - 230
Top side finish	Anti-adhesive sand	Anti-adhesive sand	Slate chips	Slate chips
Bottom side finish	Hot melt film	Hot melt film	Hot melt film	Hot melt film
Intended use				

Isopol-PL / Isopol-PL Mineral

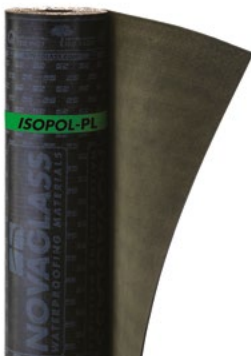
BPP -10 °C

Bitumen membrane with waterproofing mass classified as BPP (Plastomeric Polymer Bitumen) in accordance with standard UNI 8818, comprised of distilled bitumen modified with high-quality polyolefin polymers (APP) obtained through a process of polymerisation catalysed by metallocenes, and composite internal reinforcement in non-woven continuous filament polyester geotextile stabilised with glass fibre. Product with CE marking compliant with standards EN 13707, EN 13969, EN 13970, EN 13859-1.

Cold flexibility: ≤ -10 °C (EN 1109)

In the MINERAL version, the top side has a self-protective finish with natural or coloured ceramic slate chips.

Dark Grey



Standard colour

Green*





Red*



White*



* Available on request, minimum order 2,000 m²

CHARACTERISTICS	Isopol - PL 3 mm	Isopol - PL 4 mm	Isopol - PL Mineral 4 Kg	Isopol - PL Mineral 4.5 Kg
Dimensions m	1 x 10	1 x 10	1 x 10	1 x 10
Rolls per pallet - m ²	25 - 250	20 - 200	25 - 250	23 - 230
Top side finish	Anti-adhesive sand	Anti-adhesive sand	Slate chips	Slate chips
Bottom side finish	Hot melt film	Hot melt film	Hot melt film	Hot melt film
Intended use				

Novapol/Novapol Mineral

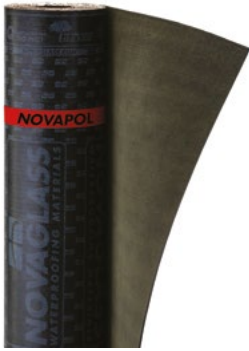
BPP -5 °C



Dark Grey



Standard colour

Bitumen membrane with waterproofing mass classified as BPP (Plastomeric Polymer Bitumen) in accordance with standard UNI 8818, comprised of distilled bitumen modified with polyolefin polymers (APP) and composite internal reinforcement in non-woven continuous filament polyester geotextile stabilised with glass fibre. Product with CE marking compliant with standards EN 13707, EN 13969, EN 13970, EN 13859-1. Cold flexibility: ≤ -5 °C (EN 1109)

In the MINERAL version, the top side has a self-protective finish with natural or coloured ceramic slate chips.

CHARACTERISTICS	Novapol 3 mm	Novapol 4 mm	Novapol Mineral 4 Kg	Novapol Mineral 4.5 Kg
Dimensions m	1 x 10	1 x 10	1 x 10	1 x 10
Rolls per pallet - m ²	25 - 250	20 - 200	25 - 250	23 - 230
Top side finish	Anti-adhesive sand	Anti-adhesive sand	Slate chips	Slate chips
Bottom side finish	Hot melt film	Hot melt film	Hot melt film	Hot melt film
Intended use				

Novabit

BPP -5 °C

Bitumen membrane with waterproofing mass classified as BPP (Plastomeric Polymer Bitumen) in accordance with standard UNI 8818, comprised of distilled bitumen modified with polyolefin polymers (APP) and internal reinforcement in reinforced glass fibre. Product with CE marking compliant with standards EN 13707, EN 13969, EN 13970.

Cold flexibility: ≤ -5 °C (EN 1109)

CHARACTERISTICS	Novabit 3 kg	Novabit 4 kg
Dimensions m	1 x 10	1 x 10
Rolls per pallet - m ²	34 - 340	25 - 250
Top side finish	Hot melt film	Hot melt film
Bottom side finish	Hot melt film	Hot melt film
Intended use		

Nova-SK/Nova-SK Mineral Nova-SK Alu

BPE -25 °C

Bitumen membrane, self-adhesive on the bottom side for torchless uses, with waterproofing mass classified as BPE in accordance with standard UNI 8818 in distilled bitumen modified with thermoplastic elastomers (SBS, SIS and special resins), which make it highly adhesive, self-sealing and highly elastic. The internal reinforcement is comprised of non-woven polyester geotextile stabilised with glass fibre. The internal reinforcement of the ALU version is also bonded to an Aluminium sheet making it absolutely impermeable to the passage of aqueous vapour. NOVA-SK and NOVA-SK ALU have a top side coated with Texface, a non-woven polypropylene geotextile; the MINERAL version on the other hand is self-protected with ceramic slate chips. All the membranes have a self-adhesive side band on the top side covered with a removable anti-adhesive film, and the bottom side coated with a removable monosiliconised film. Product with CE marking compliant with standards EN 13707, EN 13969, EN 13970, EN 13859-1. Cold flexibility: ≤ -25 °C (EN 1109)

 Standard colour
 Nova SK Mineral Red

CHARACTERISTICS	Nova-SK 2 mm	Nova-SK 3 mm	Nova-SK Mineral 3.5 Kg	Nova-SK Alu 2 mm
Dimensions m	1 x 15	1 x 10	1 x 10	1 x 15
Rolls per pallet - m ²	25 - 375	25 - 250	25 - 250	25 - 375
Top side finish	TNT Texface	TNT Texface	Slate chips	TNT Texface
Bottom side finish	Removable PE film	Removable PE film	Removable PE film	Removable PE film
Intended use				

Nova-Adhesive 20 Nova-Adhesive 20 Mineral



BPE -20 °C

Bitumen membrane, self-adhesive on the bottom side for torchless uses, with waterproofing mass classified as BPE (Elastomeric Polymer Bitumen) in accordance with standard UNI 8818 in distilled bitumen modified with thermoplastic elastomers (SBS, SIS and special resins) which make it highly adhesive, self-sealing and highly elastic. The internal reinforcement is comprised of non-woven polyester geotextile stabilised with glass fibre. NOVA-ADHESIVE 20 has a top side coated with Texface, a non-woven polypropylene geotextile; the MINERAL version on the other hand is self-protected with natural or coloured ceramic slate chips. Both have a self-adhesive side band (selvedge) on the top side covered with a removable anti-adhesive film, and the bottom side coated with a removable monosiliconised film. Product with CE marking compliant with standards EN 13707, EN 13969, EN 13859-1. Cold flexibility: ≤ -20 °C (EN 1109).



Standard colours

* Available on request, minimum order 2,000 m²

CHARACTERISTICS	Nova Adhesive 20 2 mm	Nova Adhesive 20 3 mm	Nova Adhesive 20 4 mm	Nova Adhesive 20 Mineral 3.5 kg	Nova Adhesive 20 Mineral 3.5 kg Mix	Nova Adhesive 20 Mineral 4 kg	Nova Adhesive 20 Mineral 4 kg Mix
Dimensions m	1 x 15	1 x 10	1 x 10	1 x 10	1 x 10	1 x 10	1 x 10
Rolls per pallet - m ²	25 - 375	25 - 250	20 - 200	25 - 250	25 - 250	23 - 230	23 - 230
Top side finish	TNT Texface	TNT Texface	TNT Texface	Slate chips	Slate chips	Slate chips	Slate chips
Bottom side finish	Removable PE film	Removable PE film	Removable PE film	Removable PE film	Removable PE film	Removable PE film	Removable PE film
Intended use							

Novar-CH SBS

BPE -20 °C

Bitumen membrane with certified root-puncture resistance in compliance with standard EN 13948, with waterproofing mass classified as BPE (Elastomeric Polymer Bitumen) in accordance with standard UNI 8818, comprised of distilled bitumen modified with thermoplastic elastomers (SBS) and additivated with specific chemical anti-fouling products. The internal reinforcement is comprised of a composite non-woven heavy weight continuous filament polyester geotextile stabilised with glass fibre. Product with CE marking compliant with standards EN 13707, EN 13969.

Cold flexibility: ≤ -20 °C (EN 1109).



CHARACTERISTICS	Novar-CH SBS 4 mm
Dimensions m	1 x 10
Rolls per pallet - m ²	20 - 200
Top side finish	Hot melt film
Bottom side finish	Hot melt film
Intended use	

Novar-CH

BPP -15 °C

Bitumen membrane with certified root-puncture resistance in compliance with standard EN 13948, with waterproofing mass classified as BPP (Plastomeric Polymer Bitumen) in accordance with standard UNI 8818, comprised of distilled bitumen modified with high-quality polyolefin polymers (APP) obtained through a process of polymerisation catalysed by metallocenes and additivated with specific chemical anti-fouling products. The internal reinforcement is comprised of a composite non-woven heavy weight continuous filament polyester geotextile stabilised with glass fibre. Product with CE marking compliant with standards EN 13707, EN 13969.

Cold flexibility: ≤ -15 °C (EN 1109).



CHARACTERISTICS	Novar-CH 4 mm
Dimensions m	1 x 10
Rolls per pallet - m ²	20 - 200
Top side finish	Hot melt film
Bottom side finish	Hot melt film
Intended use	

Novar-CH/S

BPP -10 °C

Bitumen anti-root membrane with waterproofing mass classified as BPP (Plastomeric Polymer Bitumen) in accordance with standard UNI 8818, comprised of distilled bitumen modified with high-quality polyolefin polymers (APP) obtained through a process of polymerisation catalysed by metallocenes and additivated with specific chemical anti-fouling products that make it resistant to root puncture. The internal reinforcement is comprised of a composite non-woven continuous filament polyester geotextile stabilised with glass fibre. Product with CE marking compliant with standards EN 13707, EN 13969. Cold flexibility: $\leq -10\text{ °C}$ (EN 1109).



CHARACTERISTICS	Novar-CH/S 4 mm
Dimensions m	1 x 10
Rolls per pallet - m ²	20 - 200
Top side finish	Hot melt film
Bottom side finish	Hot melt film
Intended use	

For more information on Soprema anti-root membranes, see the specific technical documentation where available, or contact the Soprema technical department (tech-office@soprema.it)



Eurostar/Eurostar Reflecta



BPP -30 °C

Bitumen membrane with waterproofing mass classified as BPP (Plastomeric Polymer Bitumen) in accordance with standard UNI 8818, in distilled bitumen modified with high-quality polyolefin polymers (APP) obtained through a process of polymerisation catalysed by metallocenes. The internal reinforcement is comprised of **a triple composite** non-woven heavy weight continuous filament polyester geotextile stabilised with glass fibre. The top side has a self-protective finish with Black Diamond slate micro-chips. The REFLECTA version on the other hand is self-protected with special white slate chips with high solar resistance (SR 0.699 / SRI 84.8%). Moreover, the REFLECTA version is highly resistant to hail on rigid decks, in compliance with standard EN 13583.

The membrane has obtained **Broof t2 classification** for resistance to external fire exposure in special systems pursuant to CEN TS 1187 and EN 13501-5*. Product with CE marking compliant with standards EN 13707, EN 13969, EN 13859-1 and EN 13583.

Cold flexibility: $\leq -30\text{ °C}$ (EN 1109)



CHARACTERISTICS	Eurostar 4 mm	Eurostar 5 mm	Eurostar Reflecta 4 mm (thickness on selvedge)
Dimensions m	1.1 x 7.5	1.1 x 7.5	1.1 x 7.5
Rolls per pallet - m ²	25 - 206.25	20 - 165	20 - 165
Top side finish	"Black Diamond"	"Black Diamond"	White Reflecta slate chips
Bottom side finish	Hot melt film	Hot melt film	Hot melt film
Intended use			

Hail resistance: Test report no. 379098*

*Test performed on Eurostar Reflecta



For more information see the specific technical documentation where available, or contact the Soprema technical department (tech-office@soprema.it)



***WARNING:** the performance of roofs to external fire exposure is determined by the constructive layering of the system itself as provided for in the specific test methods pursuant to CEN TS 1187. For more information on BRoof-classified layering, contact the Soprema S.r.l. Technical Department: tech-office@soprema.it

Novater SP FR

Novater SP FR - Mineral

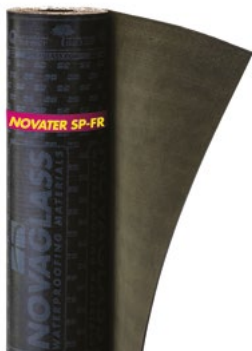
BPP -20 °C

Bitumen membrane with waterproofing mass classified as BPP (Plastomeric Polymer Bitumen) in accordance with standard UNI 8818, in distilled bitumen modified with high-quality polyolefin polymers (APP) obtained through a process of polymerisation catalysed by metallocenes. The internal reinforcement is comprised of **a triple composite** non-woven heavy weight continuous filament polyester geotextile stabilised with glass fibre. In the MINERAL version, the top side has a self-protective finish with natural or coloured ceramic slate chips. The membrane has obtained **Broof t2 and t3 classification** for resistance to external fire exposure in special systems pursuant to CEN TS 1187 and EN 13501-5*. Product with CE marking compliant with standards EN 13707, EN 13969, EN 13859-1. Cold flexibility: ≤ -20 °C (EN 1109)

Dark Grey

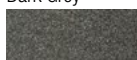

Standard colour

Green*

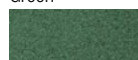

Red*



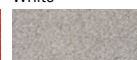

White*

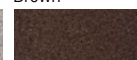

Brown*

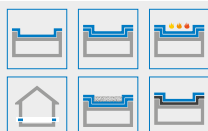
 * Available on request, minimum order 2,000 m²

CHARACTERISTICS	Novater SP FR 4 mm	Novater SP FR Mineral 4.5 kg	Novater SP FR Mineral 5 kg	Novater SP FR Mineral 4 mm (thickness on selvedge)
Dimensions m	1 x 10	1 x 10	1 x 7.5	1 x 7.5
Rolls per pallet - m ²	20 - 200	20 - 200	25 - 187.5	23 - 172.5
Top side finish	Anti-adhesive sand	Slate chips	Slate chips	Slate chips
Bottom side finish	Hot melt film	Hot melt film	Hot melt film	Hot melt film
Intended use				

Flexgum-P HFR Mineral

BPE -20 °C

Bitumen membrane with waterproofing mass classified as BPE (Elastomeric Polymer Bitumen) in accordance with standard UNI 8818, in distilled bitumen modified with thermoplastic elastomers (SBS). The internal reinforcement is comprised of **triple composite reinforcement** in non-woven heavy weight continuous filament polyester geotextile stabilised with glass fibre. The top side has a self-protective finish with natural or coloured ceramic slate chips.

The membrane has obtained **Broof t2 and t3 classification** for resistance to external fire exposure in special systems pursuant to CEN TS 1187 and EN 13501-5*. Product with CE marking compliant with standards EN 13707, EN 13969.

Cold flexibility: ≤ -20 °C (EN 1109).

Dark Grey



Standard colour

Green*



Red*



White*

 * Available on request, minimum order 2,000 m²

CHARACTERISTICS	Flexgum-P HFR Mineral 5 kg	Flexgum-P HFR Mineral 5.5 kg
Dimensions m	1 x 10	1 x 7.5
Rolls per pallet - m ²	20 - 200	23 - 172.5
Top side finish	Slate chips	Slate chips
Bottom side finish	PP film	PP film
Intended use		

Novagum-HP Mineral

BPE -25 °C

Bitumen membrane with waterproofing mass classified as BPE (Elastomeric Polymer Bitumen) in accordance with standard UNI 8818, comprised of distilled bitumen modified with thermoplastic elastomers (SBS) and composite internal reinforcement in non-woven heavy weight continuous filament polyester geotextile stabilised with glass fibre. The top side has a self-protective finish with natural or coloured ceramic slate chips. The membrane has high hail resistance on both rigid and soft decks pursuant to standard UNI EN 13583.

Product with CE marking compliant with standards EN 13707, EN 13969, EN 13583.

Cold flexibility: $\leq -25\text{ °C}$ (EN 1109)

Dark Grey



Standard colour

Green*



Red*







White*



Brown*

 * Available on request, minimum order 3,000 m²

CHARACTERISTICS	Novagum-HP Mineral 5.5 kg
Dimensions m	1 x 7.5
Rolls per pallet - m ²	20 - 172.5
Top side finish	Slate chips
Bottom side finish	PP film
Intended use	   

Hail resistance: Test report no. 347237

For more information see the specific technical documentation where available, or contact the Soprema technical department (tech-office@soprema.it)



Novabond Ponti

BPP -20 °C



Bitumen membrane with waterproofing mass classified as BPP (Plastomeric Polymer Bitumen) in accordance with standard UNI 8818, comprised of distilled bitumen modified with high-quality polyolefin polymers (APP) obtained through a process of polymerisation catalysed by metallocenes, and composite internal reinforcement in non-woven heavy weight continuous filament polyester geotextile stabilised with glass fibre. The membrane, certified for the waterproofing of concrete bridge decks and other trafficked areas of concrete in compliance with Standard EN 14695, can have asphalt laid directly on the top side.

Product with CE marking compliant with standards EN 13707, EN 13969, EN 14695.

Cold flexibility: ≤ -20 °C (EN 1109)

Bridge Deck Certification



CHARACTERISTICS	Novabond Ponti 4 mm	Novabond Ponti 5 mm	Novabond Ponti 6 mm
Dimensions m	1 x 10	1 x 7.5	1 x 7.5
Rolls per pallet - m ²	20 - 200	20 - 150	20 - 150
Top side finish	Anti-adhesive sand	Anti-adhesive sand	Anti-adhesive sand
Bottom side finish	Hot melt film	Hot melt film	Hot melt film
Intended use			

Novaponti

BPP -15 °C



Bitumen membrane with waterproofing mass classified as BPP (Plastomeric Polymer Bitumen) in accordance with standard UNI 8818, comprised of distilled bitumen modified with high-quality polyolefin polymers (APP) obtained through a process of polymerisation catalysed by metallocenes, and composite internal reinforcement in non-woven heavy weight continuous filament polyester geotextile stabilised with glass fibre. The membrane, certified for the waterproofing of concrete bridge decks and other trafficked areas of concrete in compliance with Standard EN 14695, can have asphalt laid directly on the top side.

Product with CE marking compliant with standards EN 13707, EN 13969, EN 14695.

Cold flexibility: ≤ -15 °C (EN 1109)

Bridge Deck Certification



CHARACTERISTICS	Novaponti 3 mm	Novaponti 4 mm	Novaponti 5 mm
Dimensions m	1 x 10	1 x 10	1 x 7.5
Rolls per pallet - m ²	25 - 250	20 - 200	20 - 150
Top side finish	Anti-adhesive sand	Anti-adhesive sand	Anti-adhesive sand
Bottom side finish	Hot melt film	Hot melt film	Hot melt film
Intended use			

NOTE: For waterproofing in compliance with Standard 14695, 3 mm Novaponti can only be used as an underlay for multi-layer systems.

Nova Twin

BI-COMPOUND -20 °C

Composite bitumen membrane with elasto-polymeric waterproofing mass with differentiated synergistic layers, plastomeric on the top side and elastomeric on the bottom side. The composition of the plastomeric waterproofing mass is comprised of distilled bitumen modified with polyolefin polymers (APP) obtained through a process of polymerisation catalysed by metallocenes; the elastomeric waterproofing mass on the other hand is comprised of distilled bitumen modified by a combination of thermoplastic elastomers (SBS). The internal reinforcement is comprised of a composite non-woven heavy weight continuous filament polyester geotextile stabilised with glass fibre.

In the self-protected version, the top side is finished with natural or coloured ceramic slate chips. Product with CE marking compliant with standards EN 13707, EN 13969, EN 13970.

Cold flexibility: ≤ -20 °C (EN 1109).

Dark Grey





Standard colour:

White*



* Available on request, minimum order 3,000 m²

CHARACTERISTICS	Nova Twin 4 mm	Nova Twin 4 mm (thickness on selvedge)
Dimensions m	1 x 7.5	1 x 7.5
Rolls per pallet - m ²	23 - 172.5	23 - 172.5
Top side finish	Texface	Slate chip
Bottom side finish	Hot melt film	Hot melt film
Intended use		

Novall-I

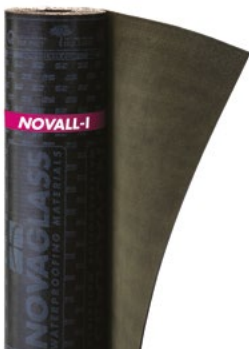
BPE -20 °C

Bitumen membrane for vapour control layer with waterproofing mass classified as BPE (Elastomeric Polymer Bitumen) in accordance with standard UNI 8818, in distilled bitumen modified with thermoplastic elastomers (SBS). The internal reinforcement is comprised of reinforced glass fibre bonded to an Aluminium sheet, making the membrane totally impermeable to the passage of aqueous vapour.

Product with CE marking compliant with standards EN 13707, EN 13969, EN 13970.

Cold flexibility: ≤ -20 °C (EN 1109).

Vapour Barrier Certification

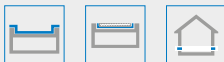

CHARACTERISTICS	Novall-I 2 mm	Novall-I 3 mm	Novall-I 4 mm
Dimensions m	1 x 15	1 x 10	1 x 10
Rolls per pallet - m ²	25 - 375	25 - 250	20 - 200
Top side finish	Anti-adhesive sand	Anti-adhesive sand	Anti-adhesive sand
Bottom side finish	Hot melt film	Hot melt film	Hot melt film
Intended use			



Novall-I «A»

BPE -20 °C

Bitumen membrane for Radon gas and vapour control layer with waterproofing mass classified as BPE (Elastomeric Polymer Bitumen) in accordance with standard UNI 8818, in distilled bitumen modified with thermoplastic elastomers (SBS). The internal reinforcement is comprised of reinforced glass fibre bonded to an Aluminium sheet, making the membrane totally impermeable to the passage of aqueous vapour and Radon gas.

Product with CE marking compliant with standards EN 13707, EN 13969, EN 13970

Cold flexibility: ≤ -20 °C (EN 1109).

CHARACTERISTICS	Novall-I «A» 3 mm	Novall-I «A» 4 mm
Dimensions m	1 x 10	1 x 10
Rolls per pallet - m ²	25 - 250	20 - 200
Top side finish	Anti-adhesive sand	Anti-adhesive sand
Bottom side finish	Hot melt film	Hot melt film
Intended use		

Novater S-A

BPP -10 °C

Bitumen membrane for Radon gas control layer, with waterproofing mass classified as BPP (Plastomeric Polymer Bitumen) in accordance with standard UNI 8818, comprised of distilled bitumen modified with high-quality polyolefin polymers (APP) obtained through a process of polymerisation catalysed by metallocenes, and composite internal reinforcement in non-woven heavy weight continuous filament polyester geotextile stabilised with glass fibre.

Product with CE marking compliant with standards EN 13707, EN 13969.

Cold flexibility: ≤ -10 °C (EN 1109).

CHARACTERISTICS	Novater S-A 4 mm
Dimensions m	1 x 10
Rolls per pallet - m ²	20 - 200
Top side finish	Anti-adhesive sand
Bottom side finish	Hot melt film
Intended use	

Novalite/Novalite Mineral

BPP -20 °C

Bitumen membrane with waterproofing mass classified as BPP (Plastomeric Polymer Bitumen) in accordance with standard UNI 8818, comprised of distilled bitumen modified with high-quality polyolefin polymers (APP) obtained through a process of polymerisation catalysed by metallocenes, and composite internal reinforcement in non-woven continuous filament polyester geotextile stabilised with glass fibre. Thanks to the special raw materials and innovative production technology used to develop the product, the membrane is extremely lightweight compared to standard products, and has a significantly lower area density with respect to similar products in the same range of equal thickness, with benefits in terms of transporting and handling the rolls. In the MINERAL version, the top side has a self-protective finish with natural or coloured ceramic slate chips. Product with CE marking compliant with standards EN 13707, EN 13969, EN 13859-1.

Cold flexibility: $\leq -20\text{ °C}$ (EN 1109).

Dark Grey



Standard colour

Green*





Red*



White*

 * Available on request, minimum order 3,000 m²

CHARACTERISTICS	Novalite 4 mm	Novalite Mineral 4 mm
Dimensions m	1 x 7.5	1 x 7.5
Rolls per pallet - m ²	25 - 187.5	25 - 187.5
Top side finish	Anti-adhesive sand	Slate chips
Bottom side finish	Hot melt film	Hot melt film
Intended use		

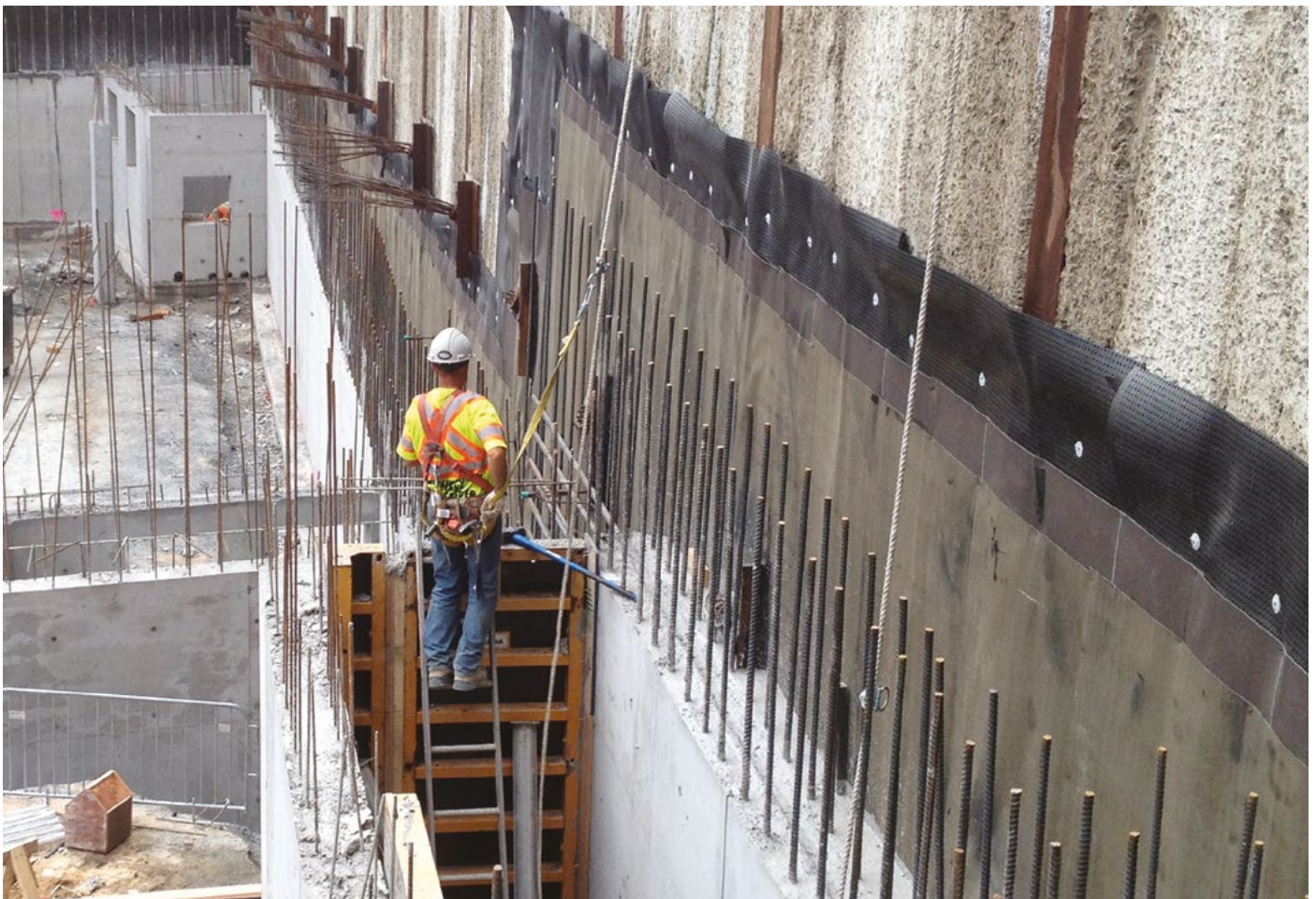

Monoter

BPP -20 °C

Mono-bitumen membrane with waterproofing mass classified as BPP (Plastomeric Polymer Bitumen) in accordance with standard UNI 8818, comprised of non-woven heavy weight continuous filament polyester geotextile, bonded on the bottom side only with waterproofing mass in distilled bitumen modified by polyolefin polymers (APP).

Functional layer for waterproofing systems designed to control chemical and physical-chemical interactions (separation layer), physical and thermophysical interactions (protection layer), or usable as a functional layer for mechanical fixing for evenly distributed points.

Product with CE marking compliant with standard EN 13859-1.

Cold flexibility: ≤ -20 °C (EN 1109).

CHARACTERISTICS	Monoter 1.5 mm
Dimensions m	1 x 20
Rolls per pallet - m ²	25 - 500
Top side finish	Hot melt film
Bottom side finish	Non-woven
Intended use	

Nova-Per



Perforated membrane comprised of internal reinforcement in glass fibre with holes with diameter 40 mm impregnated in a waterproofing mass in distilled bitumen modified by polyolefin polymers (APP).

Functional layer for waterproofing systems in "controlled semi-adherence"

CHARACTERISTICS	Nova-Per 1.1 kg
Dimensions m	1 x 30
Rolls per pallet - m ²	25 - 750
Top side finish	Hot melt film
Bottom side finish	Hot melt film
Intended use	

Nova-UP

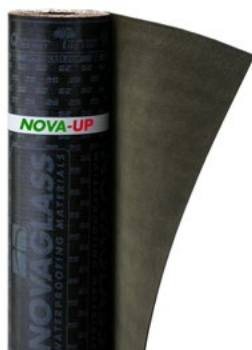
BPP -15 °C

Bitumen membrane with waterproofing mass classified as BPE (Elastomeric Polymer Bitumen) in accordance with standard UNI 8818, in distilled bitumen modified with a combination of polyolefin polymers (APP) and thermoplastic elastomers (SBS). The internal reinforcement is comprised of non-woven continuous filament polyester geotextile.

Damp-proof coating of underground vertical elements. Suitable for the waterproofing of foundation walls, vertical and horizontal underground surfaces.

Product with CE marking compliant with standards EN 13707, EN 13969.

Cold flexibility: $\leq -15\text{ °C}$ (EN 1109).

CHARACTERISTICS	Nova-UP 4 kg
Dimensions m	1 x 10
Rolls per pallet - m ²	25 - 250
Top side finish	PP film
Bottom side finish	Hot melt film
Intended use	

Nova-AL SBS/Nova-CU SBS

BPE -25 °C

Bitumen membrane with waterproofing mass classified as BPE (Elastomeric Polymer Bitumen) in accordance with standard UNI 8818, comprised of distilled bitumen modified with thermoplastic elastomers (SBS) and internal reinforcement in reinforced glass fibre.

The top side of the NOVA-AL SBS membrane is finished with an embossed aluminium sheet or embossed copper sheet for the NOVA-AL CU version, except for an exposed, unfinished side band (selvedge) for both.

Product with CE marking compliant with standard EN 13707.

Cold flexibility: $\leq -25\text{ °C}$ (EN 1109).

CHARACTERISTICS	Nova-AL SBS 4 kg	Nova-CU SBS 4 kg
Dimensions m	1 x 10	1 x 10
Rolls per pallet - m ²	25 - 250	25 - 250
Top side finish	Embossed Aluminium Sheet	Embossed Copper Sheet
Bottom side finish	Hot melt film	Hot melt film
Intended use		



Waterproofing Membranes Construction Line

Polymer Modified Bitumen Membranes

Soprema has developed a line of polymer modified bitumen membranes dedicated to specialised retail. The range includes products with a waterproofing mass composition classified as BPP (Plastomeric Polymer Bitumen) and BPE (Elastomeric Polymer Bitumen) in accordance with Standard UNI 8818.

BPP membranes, also known as elastoplastomeric membranes, are comprised of a waterproofing mass in distilled bitumen modified with polyolefin polymers (APP) and composite internal reinforcements in non-woven continuous filament geotextile, stabilised with glass fibre or glass mesh. They are characterised by high resistance to UV rays.

BPE membranes, also known as elastomeric membranes, are comprised of a waterproofing mass in distilled bitumen modified with thermoplastic elastomers (SBS) and composite internal reinforcements in non-woven continuous filament geotextile, stabilised with glass fibre or glass mesh. They are characterised by their excellent cold flexibility.

Alongside traditional torch-applied membranes, Soprema offers high-performance self-adhesive membranes. Characterised by their excellent cold flexibility, they represent a valid response to the need for safety in construction sites, fast installation, and versatility of use typical of new building technologies.

All Soprema polymer modified bitumen membranes can be supplied with different types of surface finishes.

Technical reference standards

UNI 8818: Sheets for roofing and sealing
Classification based on product description
Waterproofing mass composition acronyms:
- BPE Elastomeric Polymer Bitumen
- BPP Plastomeric Polymer Bitumen

UNI EN 13707: Flexible sheets for waterproofing -
Reinforced bitumen sheets for roof waterproofing

UNI EN 13969: Flexible sheets for waterproofing
- Bitumen damp proof sheets including bitumen
basement tanking sheets

UNI EN 13859-1: Flexible sheets for waterproofing -
Definitions and characteristics of underlays - Part 1:
Underlays for discontinuous roofing

Key for intended uses



Damp proof course



Underlays for discontinuous roofing



Under heavy ballast



Vapour Barrier



Underground elements



Underlays and middle layers



Multi-layer systems

Edilgum/Edilgum Mineral

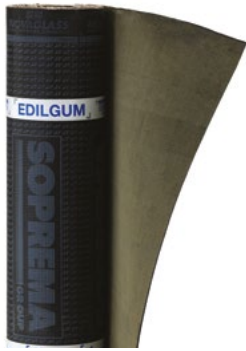
BPE -20 °C



Bitumen membrane with waterproofing mass classified as BPE (Elastomeric Polymer Bitumen) in accordance with standard UNI 8818, comprised of distilled bitumen modified with thermoplastic elastomers (SBS) and composite internal reinforcement in non-woven continuous filament polyester geotextile stabilised with glass fibre. In the MINERAL version, the top side has a self-protective finish with natural ceramic slate chips.

Product with CE marking compliant with standards EN 13707, EN 13969, EN 13859-1.
Cold flexibility: $\leq -20\text{ °C}$ (EN 1109)

Dark Grey



Standard colour

CHARACTERISTICS	Edilgum 4 mm	Edilgum Mineral 4.5 kg
Dimensions m	1 x 10	1 x 10
Rolls per pallet - m ²	20 - 200	23 - 230
Top side finish	Anti-adhesive sand	Slate chips
Bottom side finish	Hot melt film	Hot melt film
Intended use		

Ediltop/Ediltop Mineral

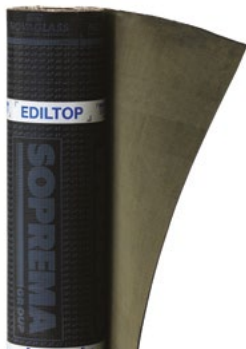
BPP 15 °C



Bitumen membrane with waterproofing mass classified as BPP (Plastomeric Polymer Bitumen) in accordance with standard UNI 8818, comprised of distilled bitumen modified with high-quality polyolefin polymers (APP) obtained through a process of polymerisation catalysed by metallocenes, and composite internal reinforcement in non-woven continuous filament polyester geotextile stabilised with glass fibre. In the MINERAL version, the top side has a self-protective finish with natural ceramic slate chips.

Product with CE marking compliant with standards EN 13707, EN 13969, EN 13859-1.
Cold flexibility: $\leq -15\text{ °C}$ (EN 1109)

Dark Grey



Standard colour

CHARACTERISTICS	Ediltop 4 mm	Ediltop Mineral 4.5 kg
Dimensions m	1 x 10	1 x 10
Rolls per pallet - m ²	20 - 200	23 - 230
Top side finish	Anti-adhesive sand	Slate chips
Bottom side finish	Hot melt film	Hot melt film
Intended use		

Edilflex/Edilflex Mineral

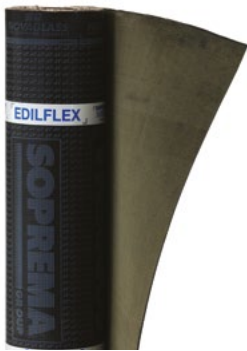
BPP -10 °C

Bitumen membrane with waterproofing mass classified as BPP (Plastomeric Polymer Bitumen) in accordance with standard UNI 8818, comprised of distilled bitumen modified with high-quality polyolefin polymers (APP) obtained through a process of polymerisation catalysed by metallocenes, and composite internal reinforcement in non-woven polyester geotextile stabilised with glass fibre. In the MINERAL version, the top side has a self-protective finish with natural or coloured ceramic slate chips. Product with CE marking compliant with standards EN 13707, EN 13969, EN 13859-1. Cold flexibility: $\leq -10\text{ °C}$ (EN 1109)

Dark Grey



Standard colour

Green*



Red*





White*



Brown*

 * Available on request, minimum order 2,000 m²

CHARACTERISTICS	Edilflex 3 mm	Edilflex 4 mm	Edilflex Mineral 4 kg	Edilflex Mineral 4.5 kg
Dimensions m	1 x 10	1 x 10	1 x 10	1 x 10
Rolls per pallet - m ²	25 - 250	23 - 230	25 - 250	23 - 230
Top side finish	Anti-adhesive sand	Anti-adhesive sand	Slate chip	Slate chip
Bottom side finish	Hot melt film	Hot melt film	Hot melt film	Hot melt film
Intended use				

Edilpol/Edilpol Mineral

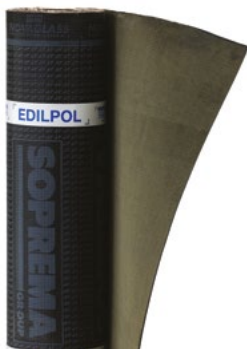
BPP -5 °C

Bitumen membrane with waterproofing mass classified as BPP (Plastomeric Polymer Bitumen) in accordance with standard UNI 8818, comprised of distilled bitumen modified with polyolefin polymers (APP) and composite internal reinforcement in non-woven polyester geotextile stabilised with glass fibre. In the MINERAL version, the top side has a self-protective finish with dark grey or multicolour mix ceramic slate chips.

Product with CE marking compliant with standards EN 13707, EN 13969, EN 13859-1. Cold flexibility: $\leq -5\text{ °C}$ (EN 1109)

Dark Grey



Multicolor Mix





Standard colours

Green*

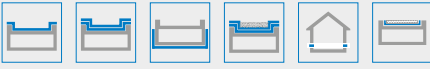

Red*

 * Available on request, minimum order 2,000 m²

CHARACTERISTICS	Edilpol 3 mm	Edilpol 4 mm	Edilpol Mineral 4 kg	Edilpol Mineral 4 kg Mix	Edilpol Mineral 4.5 kg	Edilpol Mineral 4.5 kg Mix
Dimensions m	1 x 10	1 x 10	1 x 10	1 x 10	1 x 10	1 x 10
Rolls per pallet - m ²	28 - 280	23 - 230	25 - 250	28 - 280	25 - 250	25 - 250
Top side finish	Anti-adhesive sand	Anti-adhesive sand	Slate chip	Slate chip	Slate chip	Slate chip
Bottom side finish	Hot melt film	Hot melt film	Hot melt film	Hot melt film	Hot melt film	Hot melt film
Intended use						

Edilstick/Edilstick Mineral

BPE **-15 °C**





Bitumen membrane, self-adhesive on the bottom side for torchless uses, with waterproofing mass classified as BPE (Elastomeric Polymer Bitumen) in accordance with standard UNI 8818 in distilled bitumen modified with thermoplastic elastomers (SBS, SIS and special resins), which make it highly adhesive, self-sealing and highly elastic. The internal reinforcement is comprised of non-woven polyester geotextile stabilised with glass fibre. EDILSTICK has a top side coated with Texface, a non-woven polypropylene geotextile; the MINERAL version on the other hand is self-protected with natural ceramic slate chips. Both have a self-adhesive side band (selvedge) on the top side covered with a removable anti-adhesive film, and the bottom side coated with a removable monosiliconised film. Product with CE marking compliant with standards EN 13707, EN 13969, EN 13859-1. Cold flexibility: ≤ -15 °C (EN 1109).

Dark Grey



Standard colour

CHARACTERISTICS	Edilstick 2 mm	Edilstick 3 mm	Edilstick Mineral 3.5 kg	Edilstick Mineral 4 kg
Dimensions m	1 x 15	1 x 10	1 x 10	1 x 10
Rolls per pallet - m ²	25 - 375	25 - 250	25 - 250	23 - 230
Top side finish	TNT Texface	TNT Texface	Slate chips	Slate chips
Bottom side finish	Removable PE film	Removable PE film	Removable PE film	Removable PE film
Intended use				



Edilstrip

Membrane cut into various heights: 14, 20, 25, 28, 33, 40, 50 cm.



It is possible to choose from the entire available range of products in the price list, further to verification of their availability. Products with CE marking compliant with standards EN 13707, EN 13969, EN 13859-1.

CHARACTERISTICS	Edilstrip 3 mm	Edilstrip 4 mm
Dimensions m	14, 20, 25, 28, 33, 40, 50 cm x 10 m	14, 20, 25, 28, 33, 40, 50 cm x 10 m
Rolls per pallet - m ²	Depending on height of damp proof course	Depending on height of damp proof course
Top side finish	Anti-adhesive sand	Anti-adhesive sand
Bottom side finish	Hot melt film	Hot melt film
Intended use		





Bitumen Roof Shingles

A roof in style!

Thanks to their high technical performance and exceptional visual appeal, Soprema Bitumen Roof Shingles perfectly adapt to both traditional and contemporary architectural designs.

They also offer excellent resistance to weathering, and in particular the effects of wind.

Since they are very light, bitumen roof shingles offer valuable benefits during both the design and execution of the project. Their lightness, flexibility and ease of cutting also guarantee rapid installation.

Soprema Bitumen Roof Shingles are available in a broad range of colours and shapes: classic Beaver Tail (Manitoba, Quebec), and rectangular (Columbia, Terranova, Yucon).

To complete the range, Soprema offers a line of accessories and complementary products: self-protected modified bitumen membrane with ceramic-coated basalt grit, bituminous mastic in cartridges, galvanized nails and aerators.

Soprema Bitumen Roof Shingles can be used to create any type of roof with different architectural styles, perfectly blending in with the surrounds.

Bitumen Roof Shingles

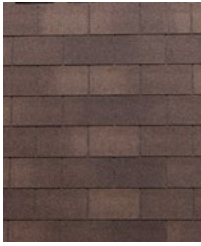

Columbia

Size: 100 x h 34 cm
 Weight: 10.5 kg/m²
 Surface covered per pack: 3.05 m²
 Packs per pallet: 52
 Surface covered per pallet: 158.6 m²

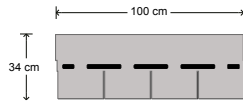

Colour Range



Manitoba

Size: 100 x h 34 cm
 Weight: 10.5 kg/m²
 Surface covered per pack: 3.05 m²
 Packs per pallet: 52
 Surface covered per pallet: 158.6 m²

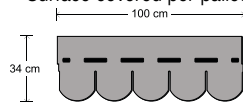

Colour Range



Terranova

Size: 100 x h 34 cm
 Weight: 9.4 kg/m²
 Surface covered per pack: 3.05 m²
 Packs per pallet: 52
 Surface covered per pallet: 158.6 m²

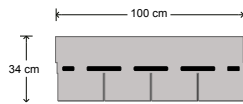

Colour Range

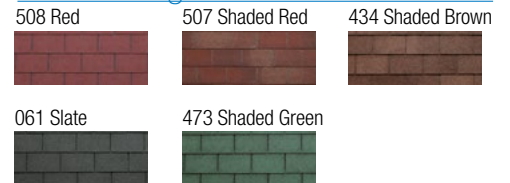

Quebec

Size: 100 x h 34 cm
 Weight: 9.4 kg/m²
 Surface covered per pack: 3.05 m²
 Packs per pallet: 52
 Surface covered per pallet: 158.6 m²

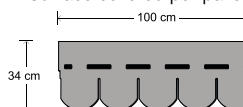

Colour Range

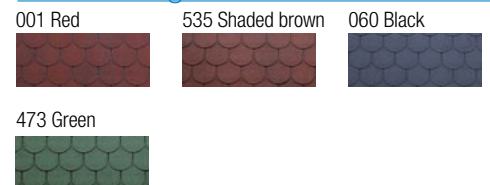

Yucon

Size: 100 x h 33.7 cm
 Weight: 11.7 kg/m²
 Surface covered per pack: 2.00 m²
 Packs per pallet: 64
 Surface covered per pallet: 128 m²

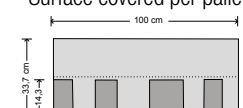

Colour Range

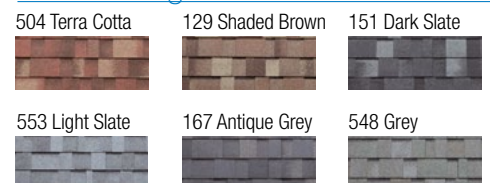

Bitumen Roof Shingles - Accessories



Alsan Mastic 2200

Bituminous Mastic in cartridges.

Contents/Packs per box

310 ml / 20 Packs per box



Galvanized Nails

Smooth galvanised nails with improved adherence.

Length/Contents

25 mm / 5 kg per box

20 mm / 5 kg per box



Standard Black Aerator

Developed to facilitate the dynamic extraction of the vapour that forms between the slab and waterproof membrane. Particularly suited for the aeration of ventilated roofs.

Contents

16 pcs per box



Special Black or Brown Aerator

Developed to facilitate the dynamic extraction of the vapour that forms between the slab and waterproof membrane. Particularly suited for the aeration of ventilated roofs. Available in black and brown.

Contents

12 pcs per box



SOPREMA
GROUP



SOPREMA
GROUP

DRAINI® BTM
Ø99mm x L600mm-ALU

Complementary Products and Accessories

The indispensable complement

A successful waterproofing system also depends on the use of totally reliable complementary products and accessories.

Soprema offers a range of products able to satisfy the needs of a continuously evolving sector, ranging from bituminous to synthetic PVC-P and TPO.

The range of aerators, pipe unions and grates is accompanied by professional waterproofing accessories, as well as non-woven reinforcements, drainage geotextiles, rubberised polyester bands, castellated membranes, self-adhesive strips and filling profiles.

Complementary Products and Accessories for Membranes



Aerator in Dutral

(other diameters and heights available on request)

Diameter/Height

75 mm / 240 mm



Roof Drain in Dutral

with perforated flange

Diameter/Height

60 mm / 240 mm
80 mm / 240 mm
100 mm / 240 mm
125 mm / 240 mm
140 mm / 240 mm
160 mm / 240 mm
140 mm / 600 mm



Corner Drain

90° in DUTRAL 100x100 square section

Length/Pieces per box

425 mm / 10 pcs



Corner Drain

90° in DUTRAL 65x100 rectangular section

Length/Pieces per box

425 mm / 10 pcs



Spier Drain

90° in DUTRAL round section

Diameter/Length

Ø 50/500 mm
Ø 63/500 mm
Ø 75/500 mm
Ø 90/500 mm
Ø 100/500 mm
Ø 110/500 mm
Ø 125/500 mm



Draini BTM

Union for rainwater drain for waterproofed roofs/terraces. It is comprised of a flexible bituminous sheet attached to a pipe section in patented aluminium.

It is available in two versions: with cylindrical pipe section and with conical pipe section.

Draini BTM straight Alu diameter

Ø 50 - Ø 63 - Ø 75 - Ø 85 - Ø 90 - Ø 95 - Ø 100 - Ø 110 - Ø 115 - Ø 120 - Ø 125 - Ø 145 - Ø 155 - Ø 195

Length

600 mm

Draini BTM truncated cone Alu diameter

Ø 80/160 - Ø 95/190 - Ø 120/240 - Ø 145/290 - Ø 195/390

Length

Depends on the size of the truncated cone

Complementary Products and Accessories



Leaf/Gravel Guard Grate

Diameter/Pieces per box

from Ø 80 to Ø 125 mm / 50 pcs



Rubber hose for burner

(8x15 - 20 BAR)

Length

15 m
20 m



Complete burner

Complete with 10, 15, 20 m rubber hose
and pressure regulator

Diameter

Ø 50 mm
Ø 70 mm



Burner

Type

Standard



Gas Regulator

Standard

Type

Standard

Complementary Products and Accessories



Oxidised bitumen

Mix of hydrocarbons.

Net contents

25 kg bags



Soprasolin

Self-adhesive waterproofing strip with high tear resistance.

Available in colours: Light Grey, Dark Grey, Shingle Red.

Width/Length/Rolls/Boxes

5 cm / 10 m / 16 rolls per box / 80 Boxes per full pallet
 10 cm / 10 m / 8 rolls per box / 80 Boxes per full pallet
 15 cm / 10 m / 8 rolls per box / 48 Boxes per full pallet
 20 cm / 10 m / 4 rolls per box / 80 Boxes per full pallet
 30 cm / 10 m / 4 rolls per box / 48 Boxes per full pallet



Elastogiunto

Special product obtained by mixing selected bitumen, thermoplastic elastomers (SBS) and other special additives designed to stabilise and protect the structure. The sealing and waterproofing power of Elastogiunto remains unaltered at both high and low operating temperatures of the elements on which it is used. Ideal for developing internal and external horizontal joints. Packed in cardboard boxes with internal non-stick film.

Weight

18 kg



Repair asphalt in bags

Pourable asphalt for urgent road repairs such as closing potholes and repairing pavements, paving driveways, footpaths, embedding pipes, manholes, etc.

Weight

25 kg per bag / 1500 kg per full pallet



Rolled bituminised felt

Rolled bituminised felt comprised of felt paper impregnated with bitumen until completely saturated.

Weight/Height/Length

300 g/m² / 100 cm / 20 m (no.99 rolls each 1x20 m/pallet)
 500 g/m² / 100 cm / 20 m (no.80 rolls each 1x20 m/pallet)



Novafond

Castellated membrane in HDPE, ideal for protecting the waterproofing of foundations and underground walls. It also creates a ventilation chamber and prevents rising damp.

Weight 400 g/m². Coil height: 2.00-2.40-3.00 m. Coil length: 20 m

No. coils/Dimensions/Surface

15 / 2.00 m x 20 m / 600 m²
 15 / 2.40 m x 20 m / 720 m²
 20 / 3.00 m x 20 m / 1200 m²

Functional Layers



PET/TT geotextile

Non-woven geotextile, 100% white polyester fibre of various weight and drainage, mechanically needle-punched without any chemical treatment and heat-treated, used as a separation, regularisation, and protection layer on the roof. Suitable for application in mechanical fixing systems.

200 g/m² Dimensions: 2.20 m x 100 m 400 and 500 g/m² Dimensions: 2.20 m x 60 m
 300 g/m² Dimensions: 2.20 m x 75 m



PET geotextile

Non-woven geotextile comprised of needle-punched green polyester fibre (100%) used as a separation, regularisation, filtering and protection layer on the roof.

200 g/m² Dimensions: 2.20 m x 100 m 400 and 500 g/m² Dimensions: 2.20 m x 60 m
 300 g/m² Dimensions: 2.20 m x 75 m



Geoland HT - Geoland HT/I

Non-woven geotextile, 100% pure high-strength polypropylene, UV stabilised, bonded with mechanical needle-punching, without any chemical or heat treatments, it is used as a separation, regularisation and protection layer for roof applications.

Geoland HT/I is recommended for underground works in contact with concrete (separation) or cementitious copings (protection).

Geoland HT		Geoland HT/I	
150 g/m ²	Dimensions: 3.30 m x 125 m	600 g/m ²	Dimensions: 6.50 m x 50 m
200 g/m ²	Dimensions: 2.20 m x 100 m	700 g/m ²	Dimensions: 6.50 m x 45 m
300 g/m ²	Dimensions: 2.20 m x 65 m	800 g/m ²	Dimensions: 6.50 m x 40 m
400 g/m ²	Dimensions: 2.20 m x 55 m	900 g/m ²	Dimensions: 6.50 m x 35 m
500 g/m ²	Dimensions: 2.20 m x 50 m	1000 g/m ²	Dimensions: 6.50 m x 30 m

Note: Higher weights available on request

Functional Layers



Vapor Flag

VAPOR FLAG polyethylene film that forms a protective shield against the migration of aqueous vapour. When applied under the thermal insulation, it protects against any condensation of the aqueous vapour due to the difference between the internal and external temperature of the building.

Vapor Flag 0.15	Thickness: 0.15 mm - Dimensions: 4.00 m x 100 m - Rolls per pallet: 18 - 7200 m ²
Vapor Flag 0.20	Thickness: 0.20 mm - Dimensions: 4.00 m x 100 m - Rolls per pallet: 14 - 5600 m ²
Vapor Flag 0.30	Thickness: 0.30 mm - Dimensions: 4.00 m x 50 m - Rolls per pallet: 14 - 2800 m ²
Vapor Flag 0.40	Thickness: 0.40 mm - Dimensions: 2.00 m x 100 m - Rolls per pallet: 14 - 2800 m ²



Vapor Flag Micro

Synthetic membrane in low-density polyethylene with micro holes with diameter 1 micron positioned across the entire surface, allowing high permeability for the passage of aqueous vapour. It is used as a separation, protection and anti-absorption layer on roofs.

Vapor Flag Micro
Thickness: 0.12 mm
Dimensions: 4.00 m x 50 m



Vapor Flag Macro

Synthetic membrane in low-density polyethylene with micro holes with 80 mm diameter positioned across the entire surface, allowing high permeability for the passage of aqueous vapour. It is used as a separation, protection and anti-absorption layer on roofs.

Vapor Flag Macro
Thickness: 0.12 mm
Dimensions: 4.00 m x 50 m

Accessory products for synthetic membranes



Soprasolar Fix Evo BITUME

Adjustable pedestal made of fibreglass-reinforced polyamide. Patented system that provides fixed supports in all cases where photovoltaic panels need to be placed level.



High lift

To join **Soprasolar® Fix Evo Tilt** pedestals to photovoltaic modules creating a 10° tilt angle. They should be used by combining them with lift locks.



Low lift

To join **Soprasolar® Fix Evo Tilt** pedestals to photovoltaic modules creating a 10° tilt angle. They should be used by combining them with lift locks.



Lift lock

Used to lock the lifts on top of the pedestals.



Universal bracket

Kit containing a waterproof nut, intermediate support brackets, M8 screws, with notched surface on the underside.



Synthetic Membranes

Synthetic Membranes

Synthetic membranes first made their appearance in the waterproofing market back in the '60s thanks to their characteristics, which efficiently responded to modern architectural design needs in the field of civil and industrial roofing, plumbing, and civil engineering. When FLAG was first introduced to the market back in 1963, it represented a point of reference for synthetic waterproofing membranes, eventually becoming a leading product in the European market. Today, it is part of the Soprema group, thanks to which its penetration of the international market has significantly improved. Synthetic waterproofing materials can be distinguished depending on their field of application. One of the main differences is between membranes having internal reinforcement with either glass fibre or polyester mesh, which are mainly used for civil and industrial roofing, and homogeneous membranes predominantly used in the plumbing and civil engineering sector. Another essential difference concerns the nature of the synthetic material itself: we can have membranes in PVC-P, considered the classic material of synthetic membranes, or in thermoplastic polyolefin, TPO, a material that first entered the market in the '90s. In both cases, the experience acquired by the Soprema group, also in the field of synthetic materials, is the best guarantee of being able to select a product most suited to the technical needs of modern-day constructions in terms of quality and speed of installation.



Technical reference standards

UNI EN 13956: Flexible sheets for waterproofing - Plastic and rubber sheets for roof waterproofing

UNI EN 13967: Flexible sheets for waterproofing - Plastic and rubber damp proof sheets including plastic and rubber basement tanking sheet

UNI EN 13361: Geosynthetic barriers - Characteristics required for use in the construction of reservoirs and dams

UNI EN 13362: Geosynthetic barriers - Characteristics required for use in the construction of canal

UNI EN 13491: Geosynthetic Barriers - Characteristics required for use as a fluid barrier in the construction of tunnels and associated underground structures

UNI EN 13492: Geosynthetic barriers - Characteristics required for use in the construction of liquid waste disposal sites, transfer stations or secondary containment

UNI CEN TS 1187: Test methods for external fire exposure to roofs

UNI EN 13501-5: Fire classification of construction products and building elements - Part 5: Classification using data from external fire exposure to roofs tests

Key for intended uses



Ballasting
Gravel



Vertical Finishes



Underground Works



Total Adhesion



Mechanical Fixing



Ballasting
Green Roof



Foundations



Total Adhesion
on Bitumen



Ballasting
Suitable for vehicles



Natural Tunnels



Ballasting
Suitable for light
foot traffic



Tanks and Reservoirs



Anti-Radon



Canals and Basins

Flagon SV

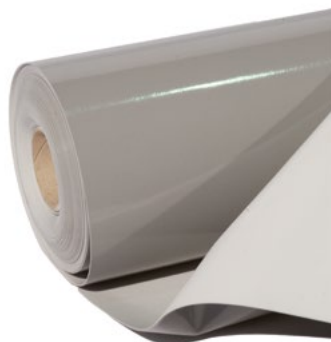
PVC-P

Synthetic membrane made from PVC-P, produced by coextrusion or coating, with signal layer, dimensionally stabilised with glass fibre, resistant to UV rays. Product with CE marking compliant with Standard EN 13956 and EN 13967.

CHARACTERISTICS	Flagon SV 1.5 mm	Flagon SV 1.8 mm	Flagon SV 2.0 mm	Flagon SV 2.4 mm
Dimensions m	1.65x20 - 2.10x20 **	1.65x20 - 2.10x20 **	1.65x20 - 2.10x20 **	1.65x20 - 2.10x20 **
Rolls per pallet - m ²	23-736 - 14-588	23-736 - 14-588	18-576 - 14-588	18-576 - 14-588
Top side colour	Light grey	Light grey	Light grey	Light grey
Bottom side colour	Dark grey	Dark grey	Dark grey	Dark grey
Intended use				

* Note: Available in RAL 7012, 6021 and 9016; on request also available in other colours from the RAL colour chart (to be verified with the Soprema S.r.l. technical department - tech-office@soprema.it) for minimum quantities of 1500 m².

** L= 1.65 m - Coating L= 2.10 m - Coextrusion



Flagon SFc

PVC-P

Synthetic membrane made from PVC-P bonded, on the bottom side, with 200 g/m² of non-woven geotextile, with single layer, produced by coating, dimensionally stabilised with glass fibre, resistant to UV rays. Product with CE marking compliant with Standard EN 13956.

CHARACTERISTICS	Flagon SFc 1.5 mm	Flagon SFc 1.8 mm	Flagon SFc 2.0 mm
Dimensions m	1.65x20	1.65x20	1.65x20
Rolls per pallet - m ²	16-528	12-396	12-396
Top side colour	Light grey	Light grey	Light grey
Bottom side colour	Dark grey	Dark grey	Dark grey
Bottom side finish	Non-woven geotextile	Non-woven geotextile	Non-woven geotextile
Intended use			



*Note: Available in RAL 7012, 6021 and 9016; on request also available in other colours from the RAL colour chart (to be verified with the Soprema S.r.l. technical department - tech-office@soprema.it) for minimum quantities of 1500 m².

Flagon SR - Flagon SRF

PVC-P



Synthetic membrane made from PVC-P reinforced with polyester mesh, with signal layer, produced by coextrusion (Flagon SR) or coating (Flagon SR and Flagon SRF), resistant to UV rays.

Products with CE marking compliant with Standard EN 13956 (Flagon SR and Flagon SRF) and EN 13361, EN 13362 (Flagon SR).

CHARACTERISTICS	Flagon SR 1.5 mm	Flagon SR 1.8 mm	Flagon SR 2.0 mm	Flagon SRF 1.5 mm	Flagon SRF 1.8 mm	Flagon SRF 2.0 mm
Dimensions m	1.60x20 - 2.10x20 - 1.05x20	1.60x20 - 2.10x20 - 1.05x20	1.60x20 - 2.10x20 - 1.05x20	1.60x20	1.60x20	1.60x20
Rolls per pallet - m ²	23-736 - 14-588 - 14-294	23-736 - 14-588 - 14-294	23-736 - 14-588 - 14-294	16-512	12-384	12-384
Top side colour	Light grey	Light grey	Light grey	Light grey	Light grey	Light grey
Bottom side colour	Dark grey	Dark grey	Dark grey	Dark grey	Dark grey	Dark grey
Bottom side finish	-	-	-	Non-woven geotextile	Non-woven geotextile	Non-woven geotextile
Intended use						

*Note: Available in RAL 7012, 6021 and 9016; on request also available in other colours from the RAL colour chart (to be verified with the Soprema S.r.l. technical department - tech-office@soprema.it) for minimum quantities of 1500 m².

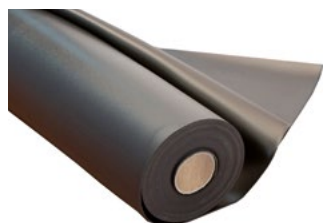
Flagon A

PVC-P

Homogeneous synthetic membrane made from PVC-P, obtained by coextrusion with the use of polymeric plasticisers with temporary resistance to contact with oils and hydrocarbons, not resistant to UV rays. Product with CE Marking compliant with standard: EN 13956, EN 13361, EN 13362, EN 13967.

Cerisie test report No. 280/2016

CHARACTERISTICS	Flagon A 1.8 mm	Flagon A 2.0 mm	Flagon A 2.4 mm
Dimensions m	2.10x20	2.10x20	2.10x20
Rolls per pallet - m ²	14-588	14-588	14-588
Top side colour	Black	Black	Black
Bottom side colour	Black	Black	Black
Intended use			

Flagon SV Strip

PVC-P

Membrane strip in grey PVC-P dimensionally stabilised with glass fibre. Resistant to UV rays.

[Flagon SV Strip](#)

Thickness: 1.5 mm
Dimensions: 0.20 m x 20 m

Flagon S (PVC for finish)

PVC-P

Homogeneous membrane in PVC-P for light grey coloured finish. Resistant to UV rays.

[Flagon S](#)

Thickness: 1.5 mm
Dimensions: 1.05 m x 20 m

Flagon S Energy Plus (PVC for finish)

PVC-P

Homogeneous membrane in PVC-P for white coloured finish. Resistant to UV rays.

[Flagon S Energy Plus](#)

Thickness: 1.5 mm
Dimensions: 1.05 m x 20 m

Flagon SV Energy Plus



Flagon SFC Energy Plus



Synthetic membrane made from PVC-P, white coloured for its entire thickness, with high solar reflectance index (SRI). Produced by coextrusion (Flagon SV) or coating (Flagon SV and Flagon SFC), dimensionally stabilised with glass fibre. High resistance to UV rays.

The Flagon SFC Energy Plus membrane is bonded on the bottom side to a 200 g/m² non-woven polyester geotextile.

Products with CE Marking compliant with Standard EN 13956 (Flagon SV Energy Plus and Flagon SFC Energy Plus)

CHARACTERISTICS	Flagon SV Energy Plus 1.5 mm	Flagon SV Energy Plus 1.8 mm	Flagon SV Energy Plus 2.0 mm	Flagon SFC Energy Plus 1.5 mm	Flagon SFC Energy Plus 1.8 mm	Flagon SFC Energy Plus 2.0 mm
Dimensions m	1.65x20 - 2.10x20 **	1.65x20 - 2.10x20 **	1.65x20 - 2.10x20 **	1.65x20	1.65x20	1.65x20
Rolls per pallet - m ²	23-736 - 14-588	23-736 - 14-588	23-736 - 14-588	16-528	12-396	12-396
Top side colour	White	White	White	White	White	White
Bottom side colour	White	White	White	White	White	White
Bottom side finish	-	-	-	Non-woven geotextile	Non-woven geotextile	Non-woven geotextile
Intended use						

** L= 1.65 m - Coating L= 2.10 m - Coextrusion

Flagon SR Energy Plus



Flagon SRF Energy Plus



Synthetic membrane made from PVC-P, white coloured for its entire thickness, with high solar reflectance index (SRI). Produced by coextrusion (Flagon SR) or coating (Flagon SR and Flagon SRF), reinforced with polyester mesh, with high resistant to UV rays.

The Flagon SRF Energy Plus membrane is bonded on the bottom side to a 200 g/m² non-woven polyester geotextile.

Products with CE Marking compliant with Standard EN 13956 (Flagon SR Energy Plus and Flagon SRF Energy Plus).

CHARACTERISTICS	Flagon SR Energy Plus 1.5 mm	Flagon SR Energy Plus 1.8 mm	Flagon SR Energy Plus 2.0 mm	Flagon SRF Energy Plus 1.5 mm	Flagon SRF Energy Plus 1.8 mm	Flagon SRF Energy Plus 2.0 mm
Dimensions m	1.60x20 - 2.10x20	1.60x20 - 2.10x20	1.60x20 - 2.10x20	1.60x20	1.60x20	1.60x20
Rolls per pallet - m ²	23-736 - 14-588	23-736 - 14-588	23-736 - 14-588	16-512	12-384	12-384
Top side colour	White	White	White	White	White	White
Bottom side colour	White	White	White	White	White	White
Bottom side finish	-	-	-	Non-woven geotextile	Non-woven geotextile	Non-woven geotextile
Intended use						

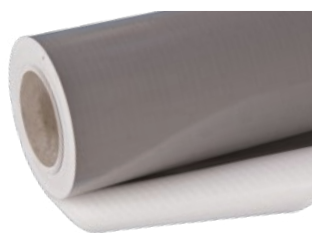

Flagon SR FR M2

PVC-P

Synthetic membrane made from PVC-P reinforced with polyester mesh, with signal layer, produced by coextrusion or coating, resistant to UV rays.

The Flagon SR FR M2 membrane has obtained **Broof T3 classification** for resistance to external fire exposure in special systems pursuant to CEN TS 1187 and EN 13501-5**.

Product with CE marking compliant with standard EN 13956.

CHARACTERISTICS	Flagon SR FR M2* 1.5 mm	Flagon SR FR M2* 1.8 mm	Flagon SR FR M2* 2.0 mm
Dimensions m	1.60x20 - 2.10x20 - 1.05x20	1.60x20 - 2.10x20 - 1.05x20	1.60x20 - 2.10x20 - 1.05x20
Rolls per pallet - m ²	23-736 - 14-588 - 14-144	23-736 - 14-588 - 14-144	23-736 - 14-588 - 14-144
Top side colour	Light grey	Light grey	Light grey
Bottom side colour	Dark grey	Dark grey	Dark grey
Intended use			

*Available in the Energy Plus version.

Flagon SR SC

PVC-P

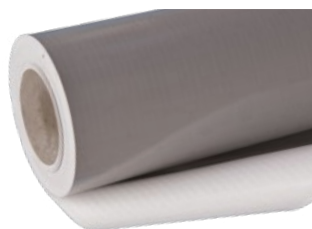

Synthetic membrane made from PVC-P reinforced with polyester mesh, with single layer, produced by coextrusion, resistant to UV rays.

The Flagon SR SC membrane has obtained **Broof T2 classification** for resistance to external fire exposure in special systems pursuant to CEN TS 1187 and EN 13501-5**.

Product with CE marking compliant with standard EN 13956.



CHARACTERISTICS	Flagon SR SC 1.5 mm	Flagon SR SC 1.8 mm	Flagon SR SC 2.0 mm
Dimensions m	1.60x20 - 2.10x20 - 1.05x20	1.60x20 - 2.10x20 - 1.05x20	1.60x20 - 2.10x20 - 1.05x20
Rolls per pallet - m ²	23-736 - 14-588 - 14-144	23-736 - 14-588 - 14-144	23-736 - 14-588 - 14-144
Top side colour	Light grey	Light grey	Light grey
Bottom side colour	Dark grey	Dark grey	Dark grey
Intended use			

****WARNING:** the performance of roofs to external fire exposure is determined by the constructive layering of the system itself as provided for in the specific test methods pursuant to CEN TS 1187. For more information on BRoof-classified layering, contact the Soprema technical department: tech-office@soprema.it

Flagon SR SC Energy Plus



PVC-P



Synthetic membrane made from PVC-P, white coloured for its entire thickness, with high solar reflectance index (SRI). Reinforced with polyester mesh, produced by coextrusion or by coating, resistant to UV rays.

The Flagon SR SC membrane has obtained **Broof T2 classification** for resistance to external fire exposure in special systems pursuant to CEN TS 1187 and EN 13501-5**.

Product with CE marking compliant with standard EN 13956.

CHARACTERISTICS	Flagon SR SC 1.5 mm	Flagon SR SC 1.8 mm	Flagon SR SC 2.0 mm
Dimensions m	1.60x20 - 2.10x20 - 1.05x20	1.60x20 - 2.10x20 - 1.05x20	1.60x20 - 2.10x20 - 1.05x20
Rolls per pallet - m ²	23-736 - 14-588 - 14-144	23-736 - 14-588 - 14-144	23-736 - 14-588 - 14-144
Top side colour	White	White	White
Bottom side colour	White	White	White
Intended use			

Flagon SR XF

PVC-P

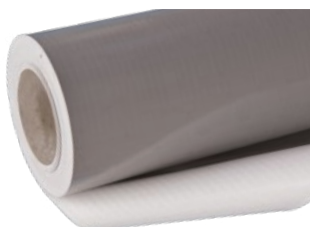

Synthetic membrane made from PVC-P reinforced with polyester mesh, with single layer, produced by coextrusion, resistant to UV rays.

Product with CE marking compliant with standard EN 13956.



CHARACTERISTICS	Flagon SR SC 1.5 mm	Flagon SR SC 1.8 mm	Flagon SR SC 2.0 mm
Dimensions m	1.60x20 - 2.10x20 - 1.05x20	1.60x20 - 2.10x20 - 1.05x20	1.60x20 - 2.10x20 - 1.05x20
Rolls per pallet - m ²	23-736 - 14-588 - 14-144	23-736 - 14-588 - 14-144	23-736 - 14-588 - 14-144
Top side colour	Light grey	Light grey	Light grey
Bottom side colour	Dark grey	Dark grey	Dark grey
Intended use			

****WARNING:** the performance of roofs to external fire exposure is determined by the constructive layering of the system itself as provided for in the specific test methods pursuant to CEN TS 1187. For more information on BRoof-classified layering, contact the Soprema technical department: tech-office@soprema.it





Flagon EP/PR - Flagon EP/PR F

TPO

Synthetic membrane made from modified polyolefin TPO, with single layer, obtained by coextrusion, resistant to UV rays, reinforced with polyester mesh.

The Flagon EP/PR F membrane is bonded on the bottom side to a non-woven geotextile.

Products with CE marking compliant with Standard EN 13956 (Flagon EP/PR and Flagon EP/PR F) and EN 13492* (Flagon EP/PR).

CHARACTERISTICS	Flagon EP/PR 1.5 mm	Flagon EP/PR 1.8 mm	Flagon EP/PR 2.0 mm	Flagon EP/PR F 1.5 mm	Flagon EP/PR F 1.8 mm	Flagon EP/PR F 2.0 mm
Dimensions m	2.10x20 - 1.05x20	2.10x20 - 1.05x20	2.10x20 - 1.05x20	2.10x20	2.10x20	2.10x20
Rolls per pallet - m ²	23-966 - 46-966	14-588 - 14-294	14-588 - 14-294	12-504	12-504	12-504
Top side colour	Sand grey	Sand grey	Sand grey	Sand grey	Sand grey	Sand grey
Bottom side colour	Black	Black	Black	Black	Black	Black
Bottom side finish	-	-	-	Non-woven geotextile	Non-woven geotextile	Non-woven geotextile
Intended use				 		

*For the authorised fields of application, contact the Soprema technical department: tech-office@soprema.it

Flagon EP/PV Strip

TPO

Membrane strip in TPO stabilised with fibre glass, in sand grey. Resistant to UV rays.

[Flagon EP/PV Strip](#)

Thickness: 1.5 mm
Dimensions: 0.20 m x 20 m

Flagon EP (TPO for finish)

TPO

Homogeneous TPO membrane for sand grey, dark grey and black finish. Resistant to UV rays.

[Flagon EP](#)

Thickness: 1.5 mm
Dimensions: 1.05 m x 20 m

Flagon EP Energy Plus (TPO for finish)



TPO

Homogeneous membrane in TPO for white coloured finish. Resistant to UV rays.

[Flagon EP Energy Plus](#)

Thickness: 1.5 mm
Dimensions: 1.05 m x 20 m

Flagon Premio Stick DE

TPO



Synthetic membrane made from modified flexible polyolefin TPO, with single layer, obtained by coextrusion, resistant to UV rays, dimensionally stabilised with glass fibre and bonded on the bottom side to a self-adhesive, non-woven geotextile protected by a removable siliconised PE film.

Product with CE marking compliant with standard EN 13956.

CHARACTERISTICS	Flagon Premio Stick DE 1.5 mm	Flagon Premio Stick DE 1.8 mm
Dimensions m	1.60x15	1.60x15
Rolls per pallet - m ²	12-288	12-288
Top side colour	Sand grey	Sand grey
Bottom side colour	Black	Black
Bottom side finish	Self-adhesive non-woven geotextile	Self-adhesive non-woven geotextile
Intended use		







Flagon EP/PV - Flagon EP/PV-F

TPO

Synthetic membrane made from modified flexible polyolefin TPO, with single layer, obtained by coextrusion, resistant to UV rays, dimensionally stabilised with glass fibre.

The Flagon EP/PV-F membrane is bonded on the bottom side to a non-woven geotextile.

Products with CE marking compliant with Standard EN 13956 (Flagon EP/PV and Flagon EP/PV-F) and EN 13967 (Flagon EP/PV).

CHARACTERISTICS	Flagon EP/PV 1.5 mm	Flagon EP/PV 1.8 mm	Flagon EP/PV 2.0 mm	Flagon EP/PV-F 1.5 mm	Flagon EP/PV-F 1.8 mm	Flagon EP/PV-F 2.0 mm
Dimensions m	2.10x20	2.10x20	2.10x20	2.10x20	2.10x20	2.10x20
Rolls per pallet - m ²	23-966	14-588	14-588	12-504	12-504	12-504
Top side colour	Sand grey	Sand grey	Sand grey	Sand grey	Sand grey	Sand grey
Bottom side colour	Black	Black	Black	Black	Black	Black
Bottom side finish	-	-	-	Non-woven geotextile	Non-woven geotextile	Non-woven geotextile
Intended use	  					



Flagon EP/PV Energy Plus Flagon EP/PV-F Energy Plus

TPO

Synthetic membrane made from modified flexible polyolefin TPO, white coloured for its entire thickness, with high solar reflectance index (SRI). Obtained by coextrusion, dimensionally stabilised with glass fibre with high resistant to UV rays.

The Flagon EP/PV-F membrane is bonded on the bottom side to a non-woven geotextile.

Products with CE marking compliant with Standard EN 13956.

CHARACTERISTICS	Flagon EP/PV Energy Plus 1.5 mm	Flagon EP/PV Energy Plus 1.8 mm	Flagon EP/PV Energy Plus 2.0 mm	Flagon EP/PV-F Energy Plus 1.5 mm	Flagon EP/PV-F Energy Plus 1.8 mm	Flagon EP/PV-F Energy Plus 2.0 mm
Dimensions m	2.10 x 20	2.10 x 20	2.10 x 20	2.10 x 20	2.10 x 20	2.10 x 20
Rolls per pallet - m ²	23-966	18-756	18-756	12-504	12-504	12-504
Top side colour	White	White	White	White	White	White
Bottom side colour	White	White	White	White	White	White
Bottom side finish	-	-	-	Non-woven geotextile	Non-woven geotextile	Non-woven geotextile
Intended use						





Flagon EP/PR Energy Plus Flagon EP/PR F Energy Plus

TPO

Synthetic membrane made from modified flexible polyolefin TPO, white coloured for its entire thickness, with high solar reflectance index (SRI). Obtained by coextrusion, reinforced with polyester mesh, with high resistant to UV rays.

The Flagon EP/PR F membrane is bonded on the bottom side to a non-woven geotextile.

Products with CE marking compliant with standard EN 13956.

CHARACTERISTICS	Flagon EP/PR Energy Plus 1.5 mm	Flagon EP/PR Energy Plus 1.8 mm	Flagon EP/PR Energy Plus 2.0 mm	Flagon EP/PR-F Energy Plus 1.5 mm	Flagon EP/PR-F Energy Plus 1.8 mm	Flagon EP/PR-F Energy Plus 2.0 mm
Dimensions m	2.10x20	2.10x20	2.10x20	2.10x20	1.60x20	1.60x20
Rolls per pallet - m ²	23-966	18-756	18-756	12-504	12-384	12-384
Top side colour	White	White	White	White	White	White
Bottom side colour	White	White	White	White	White	White
Bottom side finish	-	-	-	Non-woven geotextile	Non-woven geotextile	Non-woven geotextile
Intended use						

*For the authorised fields of application, contact the Soprema technical department: tech-office@soprema.it

Flagon EP/PR SC

TPO

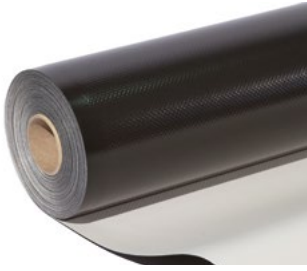

Synthetic membrane made from modified flexible polyolefin TPO, obtained by coextrusion, resistant to UV rays, reinforced with polyester mesh. Products with CE marking compliant with standard EN 13956.

The Flagon EP/PR SC membrane has obtained **Broof T2/ T3 classification** for resistance to external fire exposure in special systems pursuant to CEN TS 1187 and EN 13501-5**.



CHARACTERISTICS	Flagon EP/PR SC 1.5 mm	Flagon EP/PR SC 1.8 mm	Flagon EP/PR SC 2.0 mm
Dimensions m	2.10x20 - 1.05x20	2.10x20 - 1.05x20	2.10x20 - 1.05x20
Rolls per pallet - m ²	23-966 - 14-144	18-756 - 14-144	18-756 - 14-144
Top side colour	Sand grey	Sand grey	Sand grey
Bottom side colour	Black	Black	Black
Intended use			

Flagon EP/PR SC Energy Plus



TPO



Synthetic membrane made from modified flexible polyolefin TPO, white coloured for its entire thickness, with high solar reflectance index (SRI). Obtained by coextrusion, resistant to UV rays, reinforced with polyester mesh. Products with CE marking compliant with standard EN 13956.

The Flagon EP/PR SC membrane has obtained **Broof T2/ T3 classification** for resistance to external fire exposure in special systems pursuant to CEN TS 1187 and EN 13501-5**.

CHARACTERISTICS	Flagon EP/PR SC 1.5 mm	Flagon EP/PR SC 1.8 mm	Flagon EP/PR SC 2.0 mm
Dimensions m	2.10x20 - 1.05x20	2.10x20 - 1.05x20	2.10x20 - 1.05x20
Rolls per pallet - m ²	23-966 - 14-144	18-756 - 14-144	18-756 - 14-144
Top side colour	White	White	White
Bottom side colour	White	White	White
Intended use			

****WARNING:** the performance of roofs to external fire exposure is determined by the constructive layering of the system itself as provided for in the specific test methods pursuant to CEN TS 1187. For more information on BRoof-classified layering, contact the Soprema technical department: tech-office@soprema.it

Flagon EP/PR XF

TPO

Synthetic membrane made from modified polyolefin TPO, with single layer, obtained by coextrusion, resistant to UV rays, reinforced with polyester mesh. Products with CE marking compliant with standard EN 13956.

Product with CE marking compliant with standard EN 13956.



CHARACTERISTICS	Flagon EP/PR XF 1.5 mm	Flagon EP/PR XF 1.8 mm	Flagon EP/PR XF 2.0 mm
Dimensions m	1.05x20 - 2.10x20	1.05x20 - 2.10x20	1.05x20 - 2.10x20
Rolls per pallet - m ²	14-144 - 23-966	14-144 - 23-966	14-144 - 23-966
Top side colour	Sand grey	Sand grey	Sand grey
Bottom side colour	Black	Black	Black
Intended use			

Copper Art SR

PVC-P



Synthetic membrane made from PVC-P Copper Art for systems with mechanical fixing, reinforced with polyester mesh. Produced by subsequent coatings of a polymeric compound with copper particles incorporated into the surface skins, giving the membrane the aesthetic characteristics of the metal itself. Resistant to UV rays, with CE marking compliant with Standard EN 13956.

CHARACTERISTICS	Copper Art SR 1.8mm
Dimensions m	1.60 x 20
Rolls per pallet - m ²	12 - 384
Top side colour	Copper
Bottom side colour	Copper
Intended use	

Copper Art SFc

PVC-P



Copper Art synthetic membrane made from PVC-P for total adhesion systems, dimensionally stabilised with glass fibre and bonded on the bottom side with a non-woven geotextile. Produced by subsequent coatings of a polymeric compound with copper particles incorporated into the surface skins, giving the membrane the aesthetic characteristics of the metal itself. Resistant to UV rays, with CE marking compliant with Standard EN 13956.

CHARACTERISTICS	Copper Art SFc 1.8mm
Dimensions m	1.65 x 20
Rolls per pallet - m ²	12 - 396
Top side colour	Copper
Bottom side colour	Copper
Bottom side finish	Non-woven geotextile
Intended use	

Copper Art SRF

PVC-P



Specification item: Copper Art waterproofing made from synthetic membrane in PVC-P for systems with mechanical fixing, reinforced with polyester mesh and bonded on the bottom side with a non-woven polyester geotextile. Produced by subsequent coatings of a polymeric compound with copper particles incorporated into the surface skins, giving the membrane the aesthetic characteristics of the metal itself. Resistant to UV rays, with CE marking compliant with Standard EN 13956.

CHARACTERISTICS	Copper Art SRF 1.8mm
Dimensions m	1.60 x 20
Rolls per pallet - m ²	12 - 384
Top side colour	Copper
Bottom side colour	Copper
Bottom side finish	Non-woven geotextile
Intended use	

Copper Art SV

PVC-P



Synthetic membrane made from PVC-P for Copper Art finishes, dimensionally stabilised with glass fibre. Produced by subsequent coatings of a polymeric compound with copper particles incorporated into the surface skins, giving the membrane the aesthetic characteristics of the metal itself. Resistant to UV rays, with CE marking compliant with Standard EN 13956.

CHARACTERISTICS	Copper Art SV 1.5mm
Dimensions m	1.65 x 20
Rolls per pallet - m ²	12 - 384
Top side colour	Copper
Bottom side colour	Copper
Intended use	

Silver Art Glossy SR

PVC-P



Silver Art synthetic membrane made from PVC-P for systems with mechanical fixing, reinforced with polyester mesh and surface-lacquered. Produced by subsequent coatings of a polymeric compound with aluminium particles incorporated into the surface skins, creating a special finish that resembles a flexible aluminium sheet. Resistant to UV rays, with CE marking compliant with Standard EN 13956.

CHARACTERISTICS	Silver Art Glossy SR 1.8mm
Dimensions m	1.60 x 20
Rolls per pallet - m ²	12 - 384
Top side colour	Aluminium
Bottom side colour	Aluminium
Intended use	

Silver Art Glossy SFc

PVC-P



Silver Art synthetic membrane made from PVC-P for total adhesion systems, dimensionally stabilised with glass fibre, lacquered on the surface and bonded on the bottom side with a non-woven geotextile. Produced by subsequent coatings of a polymeric compound with aluminium particles incorporated into the surface skins, giving the membrane the aesthetic characteristics of the metal itself. Resistant to UV rays, with CE marking compliant with Standard EN 13956.

CHARACTERISTICS	Silver Art Glossy SFc 1.8mm
Dimensions m	1.65 x 20
Rolls per pallet - m ²	12 - 396
Top side colour	Aluminium
Bottom side colour	Aluminium
Bottom side finish	Non-woven geotextile
Intended use	

Silver Art Glossy SRF

PVC-P



Silver Art synthetic membrane made from PVC-P for systems with mechanical fixing, reinforced with polyester mesh, lacquered on the surface and bonded on the bottom side with a non-woven polyester geotextile. Produced by subsequent coatings of a polymeric compound with aluminium particles incorporated into the surface skins to create the special effect, which is stable over time. Resistant to UV rays, with CE marking compliant with Standard EN 13956.

CHARACTERISTICS	Silver Art Glossy SRF 1.8mm
Dimensions m	1.60 x 20
Rolls per pallet - m ²	12 - 384
Top side colour	Aluminium
Bottom side colour	Aluminium
Bottom side finish	Non-woven geotextile
Intended use	

Silver Art Glossy SV

PVC-P



Silver Art synthetic membrane made from PVC-P for Silver Art finishes, dimensionally stabilised with glass fibre and lacquered on the surface. Produced by subsequent coatings of a polymeric compound with aluminium particles incorporated into the surface skins, creating a special finish that resembles a flexible aluminium sheet. Resistant to UV rays, with CE marking compliant with Standard EN 13956.

CHARACTERISTICS	Silver Art Glossy SV 1.5mm
Dimensions m	1.65 x 20
Rolls per pallet - m ²	12 - 384
Top side colour	Aluminium
Bottom side colour	Aluminium
Intended use	

Flagon BSL

PVC-P



Synthetic membrane made from homogeneous PVC-P, obtained by coextrusion, not resistant to UV rays. The top and bottom sides are different coloured to allow the creation of the signal layer system. Product with CE marking compliant with standard EN 13491 and EN 13967

CHARACTERISTICS	Flagon BSL 1.5 mm	Flagon BSL 2.0 mm
Dimensions m	2.10 x 20	2.10 x 20
Rolls per pallet - m ²	23 - 966	18 - 756
Top side colour	Light green	Light green
Bottom side colour	Dark grey	Dark grey
Intended use		

Flagon BT/I

PVC-P



Synthetic membrane in homogeneous PVC-P, transparent, obtained by coextrusion, not resistant to UV rays. Product with CE marking compliant with standard EN 13491 and EN 13967.

CHARACTERISTICS	Flagon BT/I 1.5 mm	Flagon BT/I 2.0 mm	Flagon BT/I 3.0 mm
Dimensions m	2.10x20	2.10x20	2.10x20
Rolls per pallet - m ²	23 - 966	18 - 756	14 - 588
Top side colour	Transparent	Transparent	Transparent
Bottom side colour	Transparent	Transparent	Transparent
Intended use			

Flagon BT/ST

PVC-P

Synthetic membrane in homogeneous PVC-P, transparent, obtained by coextrusion, not resistant to UV rays. With embossed surface for application in vacuum systems. Product with CE marking compliant with standard EN 13491 and EN 13967.



CHARACTERISTICS	Flagon BT/ST 2.0 mm	Flagon BT/ST 2.4 mm
Dimensions m	1.95x20	1.95x20
Rolls per pallet - m ²	18 - 702	14 - 546
Top side colour	Transparent	Transparent
Bottom side colour	Transparent	Transparent
Intended use		

Flagon PM-SL

TPO

Synthetic membrane made from modified flexible polyolefin TPO, homogeneous, not resistant to UV rays. The top and bottom sides are different coloured to allow the creation of the signal layer system. Product with CE marking compliant with standard EN 13491.



CHARACTERISTICS	Flagon PM-SL 2.0 mm
Dimensions m	2.10 x 20
Rolls per pallet - m ²	18 - 756
Top side colour	Green
Bottom side colour	Black
Intended use	 

Flagon P

TPO

Synthetic membrane, made from modified flexible polyolefin TPO, obtained by coextrusion, dimensionally stabilised with glass fibre, not resistant to UV rays. The top and bottom sides are different coloured to allow the creation of the signal layer system. Product with CE marking compliant with standard EN 13491 and EN 13967.

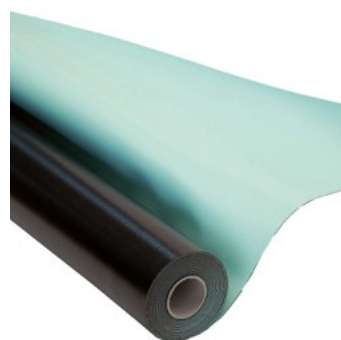

CHARACTERISTICS	Flagon P 2.0 mm	Flagon P 3.0 mm
Dimensions m	2.10x20	2.10x20
Rolls per pallet - m ²	18 - 756	11 - 462
Top side colour	Light green	Light green
Bottom side colour	Black	Black
Intended use	 	



MEMBRANES FOR SPECIAL APPLICATIONS

Flagon RP

PVC-P

Synthetic membrane in homogeneous PVC-P, obtained by coextrusion. The top and bottom sides are different coloured to allow the creation of the signal layer system. Membraned used as Anti-Radon barrier. Product with CE marking compliant with standard EN 13491 and EN 13967.



CHARACTERISTICS	Flagon RP 1.5 mm	Flagon RP 2.0 mm
Dimensions m	2.10x20	2.10x20
Rolls per pallet - m ²	23 - 966	18 - 756
Top side colour	Yellow	Yellow
Bottom side colour	Black	Black
Intended use	 	

Flagon CSL

PVC-P

Synthetic membrane in PVC-P, obtained by coextrusion, homogeneous, resistant to UV rays. The top and bottom sides are different coloured to allow the creation of the signal layer system. Product with CE marking compliant with standards EN 13361, EN 13362, EN 13492.

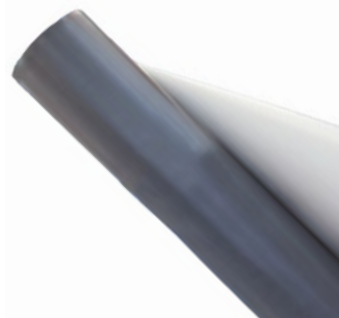

CHARACTERISTICS	Flagon CSL 1.5 mm	Flagon CSL 1.8 mm	Flagon CSL 2.0 mm
Dimensions m	2.10x20	2.10x20	2.10x20
Rolls per pallet - m ²	23 - 966	18 - 756	18 - 756
Top side colour	Light grey	Light grey	Light grey
Bottom side colour	Dark grey	Dark grey	Dark grey
Intended use			

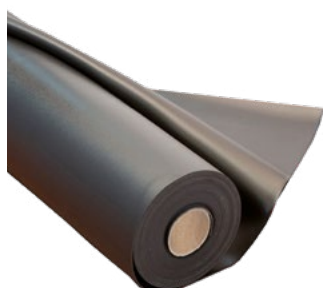

Flagon CS

PVC-P

Synthetic membrane in PVC-P, obtained by coextrusion, homogeneous. It is highly resistant against attacks by micro-organisms and roots. Not resistant to UV rays. Product with CE marking compliant with standards EN 13361, EN 13362, EN 13956, EN 13967.

CHARACTERISTICS	Flagon CS 1.5 mm	Flagon CS 1.8 mm	Flagon CS 2.0 mm
Dimensions m	2.10x20	2.10x20	2.10x20
Rolls per pallet - m ²	23 - 966	18 - 756	18 - 756
Top side colour	Dark grey	Dark grey	Dark grey
Bottom side colour	Black	Black	Black
Intended use			



Flagon GEO P

TPO

Synthetic membrane in modified flexible polyolefin TPO, obtained by coextrusion, dimensionally stabilised with glass fibre, resistant to UV rays. The top and bottom sides are different coloured to allow the creation of the signal layer system. Product with CE marking compliant with standards EN 13492*, EN 13361 and EN 13362.

CHARACTERISTICS	Flagon GEO P 1.5 mm	Flagon GEO P 1.8 mm	Flagon GEO P 2.0 mm
Dimensions m	2.10x20	2.10x20	2.10x20
Rolls per pallet - m ²	23 - 966	18 - 756	18 - 756
Top side colour	Light green	Light green	Light green
Bottom side colour	Black	Black	Black
Intended use			

*For the authorised fields of application, contact the Soprema technical department.

Flagon AT

PVC-P

Synthetic membrane made from PVC-P, obtained by coextrusion, resistant to UV rays, homogeneous, white coloured. Certified for contact with drinking water**. Product with CE marking compliant with standards EN 13361, EN 13362. Available on request in a special dark grey colour (RAL 7037) for waterproofing fish tanks





CHARACTERISTICS	Flagon AT 1.5 mm	Flagon AT 2.0 mm
Dimensions m	2.10x20	2.10x20
Rolls per pallet - m ²	23 - 966	14 - 588
Top side colour	White	White
Bottom side colour	White	White
Intended use		

Flagon SR/AT

PVC-P

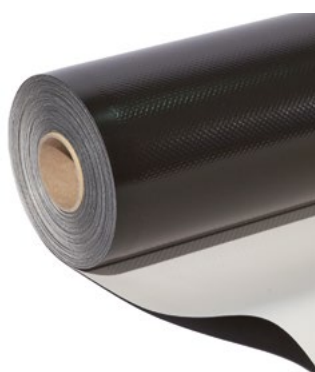
Synthetic membrane made from PVC-P, obtained by coextrusion, resistant to UV rays, reinforced with polyester mesh. Certified for contact with drinking water**. Product with CE marking compliant with standards EN 13956, EN 13361, EN 13362.



CHARACTERISTICS	Flagon SR/AT 1.5 mm	Flagon SR/AT 1.8 mm
Dimensions m	1.60x20	1.60x20
Rolls per pallet - m ²	23 - 966	23 - 966
Top side colour	Light grey	Light grey
Bottom side colour	Dark grey	Dark grey
Intended use	 	

Flagon GEO P/AT

TPO

Synthetic membrane in modified flexible polyolefin TPO, obtained by coextrusion, with single layer, dimensionally stabilised with glass fibre, resistant to UV rays. Certified for contact with drinking water**. Product with CE marking compliant with standards EN 13361, EN 13362.



CHARACTERISTICS	Flagon GEO P/AT 1.5 mm	Flagon GEO P/AT 1.8 mm	Flagon GEO P/AT 2.0 mm
Dimensions m	2.10x20	2.10x20	2.10x20
Rolls per pallet - m ²	23 - 966	18 - 756	18 - 756
Top side colour	Light green	Light green	Light green
Bottom side colour	Black	Black	Black
Intended use	 		

Flagon E

PVC-P

Synthetic membrane in homogeneous PVC-P, obtained by coextrusion, highly resistant to micro-organisms and resistant to UV rays. Product with CE marking compliant with standards EN 13361, EN 13492*.



CHARACTERISTICS	Flagon E 1.5 mm	Flagon E 2.0 mm
Dimensions m	2.10x20	2.10x20
Rolls per pallet - m ²	23 - 966	18 - 756
Top side colour	Dark grey	Dark grey
Bottom side colour	Dark grey	Dark grey
Intended use		

*For the authorised fields of application, contact the Soprema technical department.

Flagon PVC PZ

PVC-P

Synthetic protective membrane in PVC-P, homogeneous, obtained by coextrusion, not resistant to UV rays.

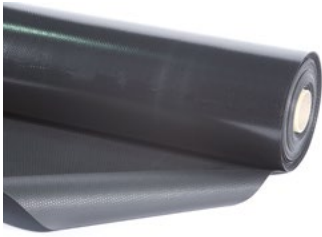

CHARACTERISTICS	Flagon PVC PZ 1.5 mm	Flagon PVC PZ 2.0 mm
Dimensions m	2.10x20	2.10x20
Rolls per pallet - m ²	23 - 966	18 - 756
Top side colour	Black	Black
Bottom side colour	Black	Black
Intended use		

Flagon PVC Walkway

PVC-P

Synthetic protective membrane in PVC-P for walkable areas on roofing in PVC-P, dimensionally stabilised with glass fibre, resistant to UV rays.

The top side is embossed to make the membrane non-slip.

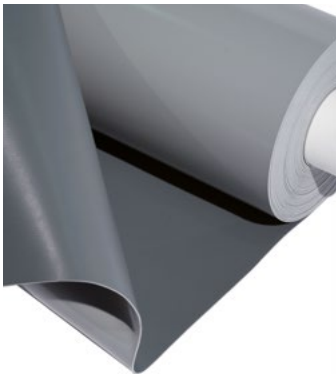

CHARACTERISTICS	Flagon PVC Walkway 1.8 mm
Dimensions m	1.50x20
Rolls per pallet - m ²	12 - 360
Top side colour	Dark grey
Bottom side colour	Dark grey
Intended use	

Flagon PVC Walkway Supergrip

PVC-P

Synthetic membrane in PVC-P with embossed finish and high non-slip and protective performance. Resistant to UV rays, with high mechanical and puncture resistance.

Tested for slip resistance, according to BS 7976-2 104/40.2 and DIN 51130 R10





CHARACTERISTICS	Flagon PVC Walkway Supergrip 4.0 mm
Dimensions m	0.76x15
Top side colour	Grey
Bottom side colour	Grey
Intended use	

Flagon TPO PZ

TPO

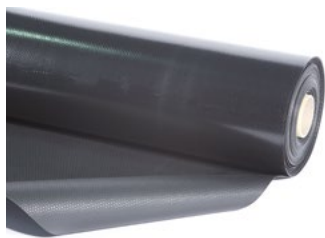
Synthetic membrane in modified polyolefin TPO, homogeneous, obtained by coextrusion, not resistant to UV rays.



CHARACTERISTICS	Flagon TPO PZ 2.0 mm
Dimensions m	2.10x20
Rolls per pallet - m ²	18 - 756
Top side colour	Black
Bottom side colour	Black
Intended use	 



Flagon TPO Walkway

TPO

Synthetic membrane in modified polyolefin TPO, for protection of walkable areas on roofing in TPO. Dimensionally stabilised with glass fibre. Resistant to UV rays.

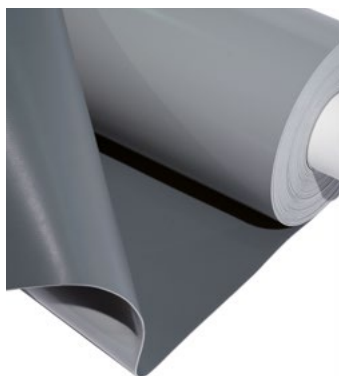
The top side is embossed to make the membrane non-slip.



CHARACTERISTICS	Flagon TPO Walkway 1.8 mm
Dimensions m	1.00x20
Rolls per pallet - m ²	23 - 460
Top side colour	Black
Bottom side colour	Black
Intended use	 

Flagon TPO Walkway Supergrip

TPO

Synthetic membrane in modified polyolefin TPO with embossed finish and high non-slip and protective performance. Resistant to UV rays, with high mechanical and puncture resistance.

Tested for slip resistance, according to BS 7976-2 104/40.2 and DIN 51130 R10



CHARACTERISTICS	Flagon TPO Walkway Supergrip 3.9 mm
Dimensions m	0.76x15
Top side colour	Grey
Bottom side colour	Grey
Intended use	 



Flagon TS

Single layer synthetic membrane in PVC-P obtained by coating, bonded with 120 g/m² non-woven felt. Rot-proof, with good mechanical resistance and weldable with hot air. Not resistant to UV rays.

Flagon TS

Thickness: 1.4 mm
 Dimensions: 1.55 m x 20 m
 Rolls per pallet: 30 - 930 m²



Sopravap Stick Eco FR

Self-adhesive vapour barrier. Forms a protective shield against the migration of aqueous vapour.

Sopravap Stick Eco FR

Dimensions: 1.40x100



Vapobac

Vapour barrier for full, macro-perforated or perforated corrugated sheets. VAPOBAC is comprised of a 60-gram glass fibre tissue bonded to an aluminium sheet with thickness 0.04 mm.

Vapobac

Dimensions: 2.10x20



Sopravoile 120

Non-woven glass fibre tissue. SOPRAVOILE 120 is used as a separation layer between the waterproofing system and the thermal insulation panel, and as a protective layer.

Sopravoile 120

Dimensions: 2.00x100



Stratec II

Multipurpose synthetic breathable layer with high permeability to aqueous vapour. Comprised of a non-woven polypropylene film. With high tear resistance.

Stratec II

Length: 50x1.50 (75 m²)
 Weight: 12 kg (148 g/m²)
 Rolls per pallet: 20

Accessory products for synthetic membranes



Flag Top Coat Maintenance

Special coating for maintenance of TPO and PVC synthetic membranes of non-recent application. It has anti-algae and anti-mould properties, and is distinguished by the fact that its innate elasticity is maintained at both low and high temperatures. It is characterised by a UV ray protection and filtration system.

Net contents/No.Packs

15 L / 12 kg approx. / Grey 7047 / 33 packs per pallet
15 L / 12 kg approx. / Green 6011 / 33 packs per pallet

Available in other colours on request

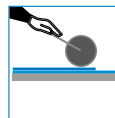



Flexocol A 89

Polyurethane adhesive material, single component, medium-low viscosity liquid, hygro-hardening, with controlled expansion. The adhesive FLEXOCOL A89 is used to adhere FLAGON TPO or FLAGON PVC waterproofing membranes bonded to geotextile on horizontal surfaces.

Contents of pack

12 kg - 10 litres



Flexocol V

Elastomeric adhesive material in solvent solution, single component, low-viscosity liquid. FLEXOCOL V is used for the contact adhesion of FLAGON PVC waterproofing membranes on vertical surfaces.

Contents of pack

8.5 kg - 10 litres

17 kg - 20 litres



Flexocol TPO

Single component solvent-based adhesive material. The adhesive FLEXOCOL TPO is used for the contact adhesion of FLAGON TPO waterproofing membranes on vertical surfaces.

Contents of pack

4.5 kg - 6 litres



Flexo Stick Primer

Adhesion promoter for application in self-adhesive systems with FLAGON PREMIO STICK DE synthetic membrane.

Contents of pack

20 kg - 16 cans per full pallet
Clear light yellow colour



Pre-drilled bar

PRE-DRILLED BAR in hot galvanised sheet metal with drilled holes every 25 mm. It is used to mechanically fix the waterproofing membrane in PVC or TPO on the roof, as a perimeter fixing element and for protruding elements.

Contents of pack

Length: 2 m
Thickness: 1.2 mm
No. pieces: 10

Accessory products for synthetic membranes



Flagofil PVC and TPO

Blue or white tear-resistant cord in PVC-P and green or orange in TPO. It is applied in roof waterproofing systems made with FLAGON PVC and FLAGON TPO synthetic membranes, as a contrast cord along the pre-drilled bars.

Dimensions

Flagofil PVC
Length: 200 m

Flagofil TPO
Length: 200 m



FLAG puncture-resistant joint

Protection element to be applied on the top of the pre-drilled bar. Protects the waterproofing membrane against possible punctures by the corners of the pre-drilled bar.

Dimensions/Contents of pack

Length: 10 cm
Pieces per pack: 50

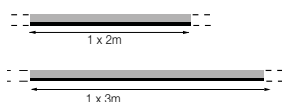

Sheet metal with visible side in PVC/TPO

Made in galvanised steel bonded to a FLAGON PVC/TPO membrane, and used to create press-folded flashings or custom profiles to be used on roofs as finishing elements in waterproofing systems made with FLAGON PVC*/TPO synthetic membranes. Also available in the Energy Plus version.

Dimensions

1.00x2.00
1.00x3.00

*Available in Copper Art and Silver Art version



Perimeter profile

Made in galvanised steel bonded to a FLAGON membrane in PVC or TPO, it is used on roofs as a finishing element in waterproofing systems made with FLAGON synthetic membranes. Resistant to weathering and UV rays. Also available in the Energy Plus version.

Contents of pack

Flagon PVC
Length: 2 m / 3 m
Pieces per pack: 10

Flagon TPO
Length: 2 m / 3 m
Pieces per pack: 10



Wall profile

Made in galvanised steel bonded to a FLAGON membrane in PVC or TPO, it is used on roofs as a finishing element for vertical closures in waterproofing systems made with FLAGON synthetic membranes. Resistant to weathering and UV rays. Also available in the Energy Plus version.

Contents of pack

Flagon PVC
Length: 3 m
Pieces per pack: 10

Flagon TPO
Length: 3 m
Pieces per pack: 10

Accessory products for synthetic membranes

Fixing plate



Made in galvanised steel bonded to a FLAGON membrane in PVC or TPO, it is used on roofs as a fixing element for under-cap vertical closures in waterproofing systems in FLAGON PVC or FLAGON TPO. Resistant to weathering and UV rays. Also available in the Energy Plus version.

Contents of pack

Flagon PVC
Length: 2 m
Pieces per pack: 10

Flagon TPO
Length: 2 m
Pieces per pack: 10



Corner 90° 145 in PVC and TPO

Prefabricated internal or external corners, obtained by moulding, in FLAGON PVC or FLAGON TPO. Used in roof waterproofing systems with FLAGON PVC or FLAGON TPO synthetic membranes. Resistant to weathering and UV rays. Also available in the Energy Plus version.

Height 145 mm.

Contents of pack

Internal corner in PVC, 20 pcs per box
External corner in PVC, 20 pcs per box

Internal corner in TPO, 20 pcs per box
External corner in TPO, 20 pcs per box



Corner 90° 95 in PVC and TPO

Prefabricated internal or external corners obtained by moulding in FLAGON PVC or FLAGON TPO. Used in roof waterproofing systems with FLAGON PVC or FLAGON TPO synthetic membranes. Resistant to weathering and UV rays. Also available in the Energy Plus version.

Height 95 mm.

Contents of pack

Internal corner in PVC, 20 pcs per box
External corner in PVC, 20 pcs per box

Internal corner in TPO, 20 pcs per box
External corner in TPO, 20 pcs per box

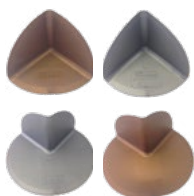

Corner 90° 95 in Copper art/Silver art

Prefabricated internal or external Copper Art and Silver Art corners, obtained by moulding, made from PVC. Used in roof waterproofing systems with Copper Art and Silver Art membranes. Resistant to weathering and UV rays.

Height 95 mm.

Contents of pack

Internal Copper Art corner, 20 pcs per box
External Copper Art corner, 20 pcs per box

Internal Silver Art corner, 20 pcs per box
External Silver Art corner, 20 pcs per box



Universal cone corner in PVC and TPO

Prefabricated internal corners, obtained by moulding, made from FLAGON PVC or FLAGON TPO. Used in roof waterproofing systems with FLAGON PVC or FLAGON TPO synthetic membranes. Resistant to weathering and UV rays. Also available in the Energy Plus version.

Contents of pack

Diameter: 180 mm
Pieces per pack: 20

Accessory products for synthetic membranes



Universal wave corner in PVC and TPO

Prefabricated internal corners, obtained by moulding, in FLAGON PVC or FLAGON TPO. Used in roof waterproofing systems with FLAGON PVC or FLAGON TPO synthetic membranes. Resistant to weathering and UV rays. Also available in the Energy Plus version.

Contents of pack

Diameter: 220 mm
Pieces per pack: 20



Decor Profile

Prefabricated pyramid-shaped element obtained by moulding in PVC/TPO. Used in roof waterproofing systems made with FLAGON PVC, FLAGON TPO, Copper Art and Silver Art synthetic membranes. Resistant to weathering and UV rays.

Dimensions/pack

Flagon PVC*
Length: 3 metres
Pieces per pack: 10

Flagon TPO**
Length: 3 metres
Pieces per pack: 10

Copper Art / Silver Art
Length: 3 metres
Pieces per pack: 10

*Available in RAL 7012 and 6021
** Available in RAL 7012



Anti-backflow union in PVC and TPO

Prefabricated element obtained by moulding and made in FLAGON PVC or FLAGON TPO. It is welded with a Leister hot air torch along the entire perimeter of the flange on the underlying FLAGON PVC or FLAGON TPO sealing element. Resistant to weathering and UV rays.

Diameter/Length

Ø 40-60:	B = 235 mm H 240 mm
Ø 75-80-90:	B = 320 mm H 240 mm
Ø 100-110-125:	B = 320 mm H 240 mm
Ø 140-150-160:	B = 386 mm H 240 mm
Ø 200:	B = 444 mm H 240 mm

Pieces per pack: 10



Draini Flag PVC and TPO straight Alu

Union for rainwater drain for waterproofed roofs/terraces. It is comprised of a synthetic membrane applied to an aluminium pipe by means of a patented system.

Diameter/Length

Ø 63-85-95-120-145-155-195 / 600 mm



Draini Flag PVC and TPO Truncated cone Alu

Union for rainwater drain for waterproofed roofs/terraces. It is comprised of a synthetic membrane applied to an aluminium pipe by means of a patented system.

Diameter/Length

Diameter mm:
80/160, 95/190, 120/240, 145/290, 195/300

Length mm: 600

Accessory products for synthetic membranes



Gravel guard with universal rod

Gravel guard in moulded HDPE, used on gravel ballasted roofs. Resistant to weathering and UV rays.

Contents of pack

Pieces per pack: 10



Universal gravel guard

Gravel guard in moulded HDPE, used on roofs. Resistant to weathering and UV rays.

Contents of pack

Pieces per pack: 10



Conical fitting in PVC and TPO

Prefabricated element, obtained by moulding, in FLAGON PVC or in FLAGON TPO. Resistant to weathering and UV rays.

Contents of pack

Pieces per pack: 10



Angular circular drain in PVC and TPO

Prefabricated element, obtained by moulding, in FLAGON PVC or FLAGON TPO. Resistant to weathering and UV rays. Excellent weldability with FLAGON PVC and FLAGON TPO membranes.

Diameter/Length

Ø 63: H 175 mm
Ø 75: H 175 mm
Ø 90: H 175 mm
Ø 110: H 210 mm

Pieces per pack: 10



Angular drain in PVC and TPO

Prefabricated element, obtained by moulding, in FLAGON PVC or FLAGON TPO. Resistant to weathering and UV rays. Excellent weldability to FLAGON PVC and FLAGON TPO membranes.

Contents of pack

Angular pipe dimensions:
65x100 mm
100x100 mm

Pieces per pack: 10

Accessory products for synthetic membranes



Angular drain fitting

Element in moulded HDPE. It is used in combination with angular drains made in FLAGON PVC or FLAGON TPO to connect these to the vertical drain pipes. Resistant to weathering and UV rays.

Contents of pack

Dimensions:
65x100 mm
100x100 mm

Pieces per pack: 10



Angular drain leaf guard

Element in moulded HDPE installed on the drain union or inlet. Press-fitted into the rainwater drain pipe, it creates a barrier to leaves, preventing these from falling into the pipes. Resistant to weathering and UV rays.

Contents of pack

Pieces per pack: 10



Flagon PVC and TPO fitting for circular through-elements

Prefabricated element obtained by moulding and made in FLAGON PVC or FLAGON TPO. Resistant to weathering and UV rays, excellent weldability to FLAGON PVC or FLAGON TPO membranes.

Contents of pack

h 250 mm	Ø 1:18	Ø 2:36	Ø 3:236
h 250 mm	Ø 1:28	Ø 2:46	Ø 3:246
h 400 mm	Ø 1:80	Ø 2:83	Ø 3:276
h 400 mm	Ø 1:110	Ø 2:113	Ø 3:312

Pieces per pack: 10



Vapour vent PVC and TPO

Prefabricated element obtained by moulding and made in FLAGON PVC or FLAGON TPO. They are used in roof waterproofing systems developed with FLAGON PVC or FLAGON TPO synthetic membranes. Resistant to weathering and UV rays, excellent weldability to FLAGON PVC or FLAGON TPO membranes.

Contents of pack

h 160 mm	Ø 1:390	Ø 2:125	Ø 3:73
h 240 mm	Ø 1:320	Ø 2:75	Ø 3:73
h 400 mm	Ø 1:390	Ø 2:125	Ø 3:73

Pieces per pack: 10



Vent cover

Element in moulded HDPE, used in combination with vent vapours made in FLAGON PVC or FLAGON TPO. Available in two models: STANDARD and ESTRAER. Resistant to weathering and UV rays.

Contents of pack

Pieces per pack: 10

Accessory products for synthetic membranes



Circular fitting in PVC and TPO

Prefabricated element obtained by moulding, made in FLAGON PVC or FLAGON TPO. It is used on roofs to give continuity to the waterproofing system around elements protruding from the roof. Resistant to weathering and UV rays. Excellent weldability.

Contents of pack

h 60 mm	Ø 1:154	Ø 2:30
h 60 mm	Ø 1:154	Ø 2:40
h 60 mm	Ø 1:194	Ø 2:60
h 60 mm	Ø 1:194	Ø 2:80
h 90 mm	Ø 1:234	Ø 2:100
h 90 mm	Ø 1:234	Ø 2:120
h 90 mm	Ø 1:274	Ø 2:140
h 90 mm	Ø 1:274	Ø 2:160

Pieces per pack: 10



Through-element fitting PVC and TPO

Prefabricated element obtained by moulding, made in FLAGON PVC or FLAGON TPO. The presence of different cross-sectional diameters allows the fitting, once cut to size, to be best adapted to the diameter of the protruding element. Resistant to weathering and UV rays. Excellent weldability.

Contents of pack

Pieces per pack: 10



Fixing washer

Discs in PVC-P or TPO with central recess to host the washer of the fixing nut. The bottom side of the washer has ribbing to guarantee good adhesion to the substrate.

Contents of pack

Flagon PVC
Diameter: 80 mm
Pieces per pack: 100

Flagon TPO
Diameter: 90 mm
Pieces per pack: 100



Injection pipette in PVC and TPO

Element in PVC or TPO with a circular flange for welding on waterproofing membranes in PVC or TPO, and a small tube to attach injection fittings and pipes to inject resins or withdraw air.

Contents of pack

Pieces per pack: 10

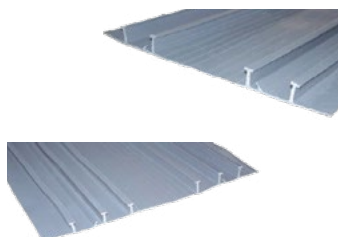

Compartmentalisation joint

The W4 compartmentalisation joint is a flexible element characterised by four feet and two wings.

The W6 compartmentalisation joint is a flexible element characterised by six feet and two wings. Available in PVC-P and TPO.

Contents of pack

Length: 25 m

Accessory products for synthetic membranes



Soprasolar Fix Evo PVC / TPO

Adjustable pedestal made of fibreglass-reinforced polyamide. Patented system that provides fixed supports in all cases where photovoltaic panels need to be placed level.



High lift

To join **Soprasolar® Fix Evo Tilt** pedestals to photovoltaic modules creating a 10° tilt angle. They should be used by combining them with lift locks.



Low lift

To join **Soprasolar® Fix Evo Tilt** pedestals to photovoltaic modules creating a 10° tilt angle. They should be used by combining them with lift locks.



Lift lock

Used to lock the lifts on top of the pedestals.



Universal bracket

Kit containing a waterproof nut, intermediate support brackets, M8 screws, with notched surface on the underside.

Accessory products

Accessories for special foundation systems

- 10 mm injection pipe
- Clip for vacuum
- 10x10 cm junction box
- Predimax Pipe 11
- Predimax 19
- White terminal
- Red terminal
- Connector for Predimax 11
- Band for Predimax 19
- Plugs for Predimax

Laying accessories and equipment

- Leister Triac Pid AT 230V 1600W
- Leister Triac Pid 1550 W heating element
- Nozzle: 20 mm
- Nozzle: 40 mm
- Nozzle: 5 mm (A1)
- Nozzle for FLAGOFIL (A2)
- Nozzle (A1) + (A2)
- Brass roller
- Roller for FLAGON PVC 40 mm
- Roller for FLAGON PVC 80 mm
- Roller for FLAGON TPO 30 mm
- Cutter for bevels and crossings
- Carver for bevels and crossings
- Flag welding tester
- Trowel for Flexocol A 89
- FLAGON scissors
- Liester Varimat automatic welder
- Complete kit for pressure test
- Liester Twinny automatic welder



- Flag sealant with permanent elasticity - box of 12 units
- Double-sided tape: length 25 m
- Double-sided butyl tape: Thickness 2.00 mm - Width 10 mm - Length 25 m
- Flagon PVC paste Can 3 litres
- Flagon TPO paste Can 3 litres
- THF solvent Can 3 litres
- THF dispenser
- FLAGON PVC Cleaner - Can 3 litres
- FLAGON TPO Cleaner - Can 3 litres



Primer - Liquid Products

Sealants, Foams and Adhesives

Waterproofing with liquid products













Soprema offers a complete range of liquid waterproofing products and special resins successfully used either in alternation or combination with traditional waterproofing systems with prefabricated membranes.

The range includes liquid waterproofing membranes, protective and cool roof system coatings, bitumen and polyurethane sealants and specific adhesives for insulation panels and bitumen membranes.

The main applications of Soprema liquid products include:

- New roofs
- Ballasted roofs with wood or tiled flooring
- Existing damaged roofs developed with bitumen or synthetic membranes
- Green roofs
- Planters
- Cool Roofs
- Protection and restoration of metal or fibre cement roofs
- Vertical reliefs on roofs developed with bitumen membranes
- Balconies and terraces

Key for intended uses

	Vertical turn-ups		Details and emerging bodies		Tileable
	Protective coating/maintenance		Walkable		Emergency repairs
	External wall protection		Internal wall protection		Cool roofs
	Water containment		Adhesive for horizontal elements		
	Adhesion promoter		Anti-root		

Bituminous Primers

Primer

Bituminous paint made from special oxidised bitumen and selected, non-recovered solvents. The Primer sets with the evaporation of the solvent, leaving an impermeable film that doesn't drip at high temperatures, and isn't brittle at low temperatures.

Consumption: 250 / 300 g/m² approx.

Code	Net contents	Colour	N. Packs/pallet
158312	18 L	Black	44

Adhesion promoter for bitumen membranes



Rapid Primer

A bituminous paint made from oxidised bitumen and pure and selected solvents, ideal for solving urgent works, where the primer necessarily needs to dry as quickly as possible to allow the immediate application of bitumen membranes. Rapid Primer has a **very quick drying time** of about 5 minutes. Rapid Primer sets with the evaporation of the solvents, leaving an impermeable film that doesn't drip at high temperatures, and isn't brittle at low temperatures.

Consumption: 250 g/m² approx.

Code	Net contents	Colour	N. Packs/pallet
113859	18 L	Black	44

Quick-drying adhesion promoter for bitumen membranes



Primer Base

Bituminous solution made from oxidised bitumen and technical solvents. The product is characterised by adequate adhesion to the substrate. Moreover, once applied, the product is not sticky on the surface.

Consumption: 250 / 300 g/m² approx.

Code	Net contents	Colour	N. Packs/pallet
231989	5 L	Black	55
232466	18 L	Black	44

Adhesion promoter for bitumen membranes



Bituminous Primers

Aquadere



Quick-drying water-based elastomeric bitumen emulsion with high dry residual weight. Aquadere is a cold-applied adhesion promoter for substrates in concrete, degreased metal or wood, which ensures the adhesion of bitumen-based waterproofing products applied hot or with a propane gas torch.

Consumption: 250 / 300 g/m² approx.



Code	Net contents	Colour	N. Packs/pallet
33925	25 L	Brown Black	27

Adhesion promoter for bitumen membranes



Elastocol 600

A cold-applied adhesion promoter for substrates in concrete, metal or wood, which promotes the adhesion of self-adhesive torchless bitumen membranes.

Consumption: 0.20-0.30 l/m² approx. for substrates in metal, and 0.30-0.40 l/m² approx. on corrugated and porous substrates (concrete or wood)



Code	Net contents	Colour	N. Packs/pallet
31008	5 L	Black	120
31033	30 L	Black	24

Adhesion promoter for bitumen membranes



Flashing System

Alsan Flashing



Product with CE Marking pursuant to **ETA-08/0114**,
CUAP 04.20-20:2007

Single component bitumen/polyurethane resin applied without primer, with the help of a roller or brush (large). Applied with special reinforcement fabrics **Voile Flashing** or **Alsan Fleece**, it is used on all vertical turn-ups in new constructions and refurbishments. Extremely compatible with all self-protecting slate membranes and many other Soprema bituminous systems.

It perfectly joins substrates in clay/cement, metal, wood, expanded perlite, cellular glass. It is resistant to UV rays.

Consumption: 1.8 / 2.1 kg/m²

Code	Weight kg	Colour	N. Packs/pallet
033996	2.5 Kg	Brown Black	126
031447	5 Kg	Brown Black	60
011590	15 Kg	Brown Black	30

Waterproof junctions with bitumen membranes

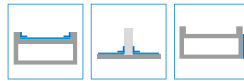

Alsan Flashing Jardin



Product with CE Marking pursuant to **ETA-08/0114**,
CUAP 04.20-20:2007

This is the additivated version of Alsan Flashing with Anti-root components. Ideal for the waterproofing of planters, green roof elements and surfaces in contact with soil.

Consumption: 1.8 / 2.1 kg/m²

Code	Weight kg	Colour	N. Packs/pallet
033990	15 Kg	Brown Black	30

Anti-Root Junctions for planters and green roofs

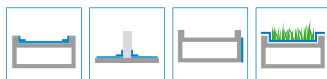

Alsan Flashing Quadro System

Alsan Flashing Quadro



Extremely adhesive, solvent-based, single-component polyurethane resin, designed for use on details and junctions between horizontal surfaces and vertical elements, on corners, joints, junctions between different materials, and anywhere at risk of cracking. Requires the specific Alsan Fleece reinforcement as indicated on the technical data sheet. It is also possible to develop **W3 waterproofing systems (25-year durability, in compliance with Standard ETAG 005)**, using the specific **Alsan Fleece** reinforcement indicated in the specific ETA Certification. It is tileable. No primer is required on: slated membranes and other Soprema bituminous systems, wooden supports, rigid PVC and mineral substrates (concrete, stone, etc.), various types of metal (see primers chart on soprema.it). Primer for details on FPO/TPO/EPDM membranes: ALSAN 103 after verifying adherence.

Consumption: 2.0 kg/m².

Code	Weight kg	Colour	N. Packs/pallet
108958	5 Kg	Grey	60

Waterproofing of junctions and small flat surfaces, tileable.

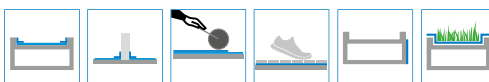

Alsan 103

ALSAN 103 is a single component polyurethane resin to be used as a base coat for TPO/FPO membranes in combination with the Alsan Flashing Quadro system.

Consumption: Approx. 100 - 150 g/m²

Code	Net contents	Colour	N. Packs/pallet
105236	1 L	Transparent	240

Adhesion promoter for bitumen membranes



Alsan 104 Spray

ALSAN 104 Spray is a single-component alkyd resin that can be sprayed as a primer for metal substrates.

Consumption: Approx. 40 - 100 g/m²

Code	Net contents	Colour	N. Packs/pallet
110956	0.5 L	Grey	-
110955	2.5 L	Grey	-

Alsan 600 System



Alsan 600



ALSAN 600 is a solvent-based, single-component polyurethane resin for waterproofing different kinds of horizontal surfaces (concrete, bituminous membranes, old ceramic coatings, etc.). ALSAN 600 systems are compliant with ETAG 005 requirements as visible waterproofing systems with W2 (10 years) or W3 (25 years) durability and P3 (normal) or P4 (intensive) walkability. ALSAN 600 is also tileable

Consumption: Approx. 1.6 - 3 Kg/m²

Code	Net contents	Colour (RAL)	N. Packs/pallet
151641	5 Kg	1001-7032-7040	60
151645	15 Kg	1001-7032-7040	30

Protective, tileable and walkable coating.



Alsan Primer H80

Alsan Primer H80 is a single-component polyurethane adhesion promoter for Alsan waterproofing systems.

Consumption: Approx. 100 - 150 g/m²

Code	Net contents	Colour	N. Packs/pallet
031534	5 Kg	Transparent	60
031607	20 Kg	Transparent	20

Adhesion promoter for bitumen membranes



Alsan 140 Kit

Alsan 140 Kit is a fast-drying, two-component polyurethane adhesion promoter for ALSAN liquid waterproofing systems

Consumption: Approx. 200 - 400 g/m²

Code	Net contents	Colour	N. Packs/pallet
112393	Composite resin A - 2.5 kg	Transparent	60
112394	Composite hardener B - 2.5 kg	Transparent	120

Adhesion promoter for bitumen membranes



Alsan 600 System

Alsan 902 CR

ALSAN 902 CR is a white reflective coating made from pure hydrophobic, aliphatic, polyurethane resins with excellent mechanical, chemical, thermal properties and insensitivity to UV rays and natural agents. It can be used to protect liquid polyurethane waterproofing such as ALSAN 600 and make Cool Roof systems.

Consumption: 200 to 500 g/m² per coat

Code	Net contents	Colour (RAL)	N. Packs/pallet
160414	5 Kg	9016	60

Protective coating for liquid waterproofing



Alsan 902 F

ALSAN 902 F is a coating made from pure hydrophobic, aliphatic, polyurethane resins with excellent mechanical, chemical, thermal properties and insensitivity to UV rays and natural agents. It can be used to protect liquid polyurethane waterproofing such as ALSAN 600.

Consumption: 200 to 500 g/m² per coat

Code	Net contents	Colour (RAL)	N. Packs/pallet
102982	15 Kg	1001-1014-7032-7040	60

Protective coating for liquid waterproofing



Alsan 902 FT

ALSAN 902 FT is a coating made from pure transparent, aliphatic, polyurethane resins. It can be used for the visible protection of tiled and non-tiled floors or as a base for pigmenting the finish with ALSAN 902 CP coloured paste.

Consumption: 200 to 500 g/m² per coat

Code	Net contents	Colour (RAL)	N. Packs/pallet
151646	4.5 Kg	Transparent	60

Protective coating for tiled floors



Alsan 902 CP + Alsan 902 FT

ALSAN 902 CP is a coloured paste to be used as a ALSAN 902 FT resin pigmentation kit

Code	Net contents	Colour	N. Packs/pallet
151646	Alsan 902 FT - 4.5 kg	Transparent	60
151647	Alsan 902 CP - 0.5 kg	1001-1015-7030-7032-7038-7045	120

Protective coating



Texpur System

Texprimer A+B



TEXPRIMER is a two-component water-soluble low-viscosity and odourless epoxy primer. TEXPRIMER is used with polyurethane liquid waterproofing systems such as TEXPUR on absorbent and non-absorbent substrates.

Mix
Consumption: 0.1 - 0.2 kg/m²

Code	Weight kg	Colour	N. Packs/pallet
71443	1 + 3 Kg	Amber	84
71441			

Primer for polyurethane liquid waterproofing systems



Texpur

TEXPUR is a single component polyurethane resin with liquid application, highly elastic, which can be applied cold and used for waterproofing.

TEXPUR is a versatile membrane for a broad range of uses as an integral part of liquid waterproofing systems. Available in red and grey. It is resistant to UV rays.

Consumption: 1.50 - 2.5 kg/m² approx. in 2/3 layers

Code	Weight kg	Colour	N. Packs/pallet
119142	6 Kg	Red and Grey	25 boxes of 4 cans each per pallet
71445	25 Kg	Red, Grey or White	25 cans per pallet

Polyurethane liquid waterproofing systems



Product with CE Marking pursuant to ETA 14/0484

Texcap F

TEXCAP F is a coating made from pure elastomeric, hydrophobic, aliphatic, polyurethane resins with excellent mechanical, chemical, thermal properties, resistant to UV rays and natural agents, and can be applied cold. It can be used to protect liquid polyurethane waterproofing such as TEXPUR. It has excellent weather resistance and excellent colour stability/protection. It dries by reaction with substrate and air moisture. Available in light grey, dark grey and red. It is resistant to UV rays.

Consumption: 0.12 - 0.25 kg/m² approx. in 1/2 layers

Code	Weight kg	Colour	N. Packs/pallet
071434	5 Kg	White, Grey, Red, Light Grey	144 cans per pallet

Coloured finish for polyurethane liquid waterproofing systems

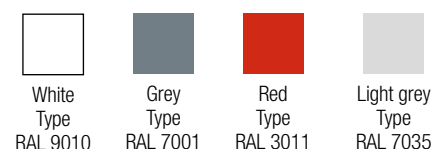

Texpur System

Texcap FT



TEXCAP FT is a coating made from pure elastomeric, hydrophobic, aliphatic, polyurethane resins with excellent mechanical, chemical, thermal properties, resistant to UV rays and natural agents, and can be applied cold. It is transparent and can be used for the visible protection of tiled and non-tiled floors. It has excellent weather resistance and excellent colour stability/protection. Dries by reaction with substrate and air moisture.

Consumption: 0.8 - 0.12 kg/m² approx. in 2/3 layers. Shake the product until obtaining a consistent mix.

Code	Weight kg	Colour	N. Packs/pallet
071436	5 Kg	Transparent	144 cans per pallet

Texkat

Accelerating catalyst for Texpur system.

Consumption: depending on external temperature, check technical data sheet.



Code	Net contents	Colour	N. Packs/pallet
71460	1 Kg	Transparent	432 cans per pallet

Waterproof coatings



UNI EN 1504-2 and UNI EN 14891

Alsan Flashing Easylastic

ALSAN Flashing Easylastic is a water-based, multi-purpose waterproofing product formulated with bitumen, selected elastomeric resins and special additives; it is resistant to weathering and UV rays, is used to waterproof, protect different types of surfaces and make under-tile waterproofing systems in compliance with UNI EN 14891.

Consumption: 1.5 to 2.5 kg/m²

Code	Weight kg	Colour	N. Packs/pallet
231070	5 Kg	RAL 7037-8007	100
231070	5 Kg	Reflex White	100
231071	20 Kg	RAL 7037-8007	33
231071	20 Kg	Reflex White	33

Waterproofing of junctions and small flat surfaces, tileable.



Easy Flashing



Multi-purpose, bituminous, thixotropic waterproofing coating featuring high adhesion capacity and flexibility even at low temperatures. It can be applied with or without TNT reinforcement. It is compatible with the majority of construction materials (cement, wood, bitumen, metal, rigid PVC, etc.). Water-based, odourless, it can also be used directly on solvent-sensitive materials such as EPS/XPS panels.

Consumption: 1.5/2.0 kg/m² approx. (for two layers)



UNI EN 1504-2 and UNI EN 14891

Code	Weight kg	Colour	N. Packs/pallet
117111	310 ml	Black	24
117106	1 Kg	Black	18
117107	5 Kg	Black	100
117108	10 Kg	Black	55
117109	20 Kg	Black	33

Liquid membrane for waterproofing various types of substrates



Easygum



EASYGUM is a ready-to-use, black, semi-dense, thixotropic, bitumen paste. A new, environmentally-friendly system for repairing deteriorated waterproofing systems, sealing technical parts, waterproofing metal and concrete surfaces. It can be used to bond any type of insulation panel onto concrete or breathable surfaces. It is resistant to UV rays.

Consumption: 2.0 kg/m² approx. (for two layers)

Code	Net contents	Weight kg	Colour	N. Packs/pallet
118727	9.15 L	10 Kg	Black	55
118728	18.45 L	20 Kg	Black	44

Liquid membrane for waterproofing various types of substrates



Waterproof coatings



Campolin



Elastomeric waterproofing coating, made of acrylic copolymers in water emulsion compliant with DMS 20/08/1999 as an encapsulating system (type A- B - C) for asbestos cement. Protects the substrate against UV rays

Consumption: 600 / 800 g/m²

Code	Weight kg	Colour	N. Packs/pallet
110717	20 Kg	9010 - 7004 - 8023 - 6010 - 3002	27

Protective coating.



Campolin Fiber



Elastomeric waterproof coating, made from acrylic copolymers in aqueous emulsion, reinforced with polypropylene fibres that allow application without reinforcement. With a minimum thickness of 1.3 mm, it is walkable-resistant according to cat. P3 - Etag 005. Protects the substrate against UV rays. The substrate must guarantee proper rainwater drainage.

The product is not resistant to stagnant water. Available in White/Grey/Terracotta/Green

Consumption: 600 / 700 g/m² approx. (per layer)

Code	Weight kg	Colour (RAL)	N. Packs/pallet
110717	5 Kg	9010 - 7004 - 8023 - 6010 - 3002	100
110719	20 Kg	9010 - 7004 - 8023 - 6010 - 3002	27

Walkable liquid membrane

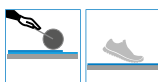

Product with CE marking compliant with standard **EN13813**



Emufal Solid



EMUFAL SOLID is a thick bitumen coating modified by special additives, in aqueous emulsion. It offers high viscosity and consistency and is used as a coating, protection for foundations, etc., or as a bitumen treatment to protect various types of surfaces and concretes. It is water-soluble. Easy to apply with a trowel, roller, brush, and adheres to wet surfaces.

Consumption: 250 g/m² approx.

Code	Weight kg	Colour	N. Packs/pallet
114178	25 Kg	Black	22

Thick bitumen coating



Waterproof protections



Product with CE Marking compliant with Standard EN1504-2 - 0505 - CPR-1207

White Reflecta Plus

Ready-to-use protective and decorative paint, formulated with special synthetic resins that form a film able to follow the deformations and expansions of the waterproofing materials on which it is applied. Its high reflectivity reduces heat absorption, with subsequent energy savings in terms of the building's cooling systems. Protects the substrate against UV rays.

Consumption: 300 / 400 g/m² approx. (per layer)

Code	Weight kg	Colour	N. Packs/pallet
154971	18 Kg	White Reflecta	33

High reflectance coating

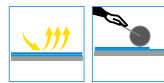

Cural

Semi-dense formula made with elastomeric bitumen, aluminium pigments, fibres, mineral fillers and volatile solvents. It is used as a bitumen coating for the refurbishment and renewal of existing waterproofing systems. The special pigmentation of CURAL is designed to make the product look like aluminium. Protects the substrate against UV rays.

Consumption: 300 g/m² approx.

Code	Weight kg	Colour	N. Packs/pallet
33928	5 Kg	Aluminium	90
31354	25 Kg	Aluminium	30

High-performance formula for protection and maintenance of bitumen membranes



Aluminium Paint

Bituminous aluminium paint with high hiding and reflective power characterised by a high adhesion coefficient on all bituminous surfaces. Its ideal application is as a protective paint for bitumen membranes. Protects the substrate against UV rays.

Consumption: 0.3 kg/m² approx.

Code	Net contents	Weight kg	Colour	N. Packs/pallet
232563	4500 ml	5 Kg	Aluminium	100
232562	16.45 L	18 Kg	Aluminium	44

Protection and Maintenance of bitumen membranes



Waterproof protections

Eco Color

Coloured coating made of selected synthetic resins in aqueous dispersion and special additives. It offers high viscosity and consistency and is used as a coating, protection for foundations, etc., or as a bitumen treatment to protect various types of surfaces and concretes. It is water-soluble. Easy to apply with a trowel, roller, brush, and adheres to wet surfaces.



Consumption: 400 to 700 g/m²

Code	Weight kg	Colour	N. Packs/pallet
232111	5 Kg	Red	55
232111	5 Kg	Grey - Green	55
113980	20 Kg	Red	33
113980	20 Kg	Grey - Green	33

Protective coating



Liquid Products - Accessories

Reinforcement fabrics

- Alsan Voile Flashing (waterproof composite reinforcement)
- Alsan Fleece-B (pre-drilled polyester TNT)



PRODUCT	Dimensions m	Length m
Alsan Voile Flashing	50 x 0.10	50 m
Alsan Fleece 110 P 0.15/50 (Alsan Voile P)	50 x 0.15	50 m
Alsan Fleece 110 P 0.20/50 (Alsan Voile P)	50 x 0.20	50 m
Alsan Fleece 110 P 0.25/50 (Alsan Voile P)	50 x 0.25	50 m
Alsan Fleece 110 P 0.50/50 (Alsan Voile P)	50 x 0.50	50 m
Alsan Fleece 110 P 1.05/50 (Alsan Voile P)	50 x 1.05	50 m
Alsan Fleece 165 B	50 x 0.20	50 m
Alsan Fleece 165 B	50 x 1.05	50 m



Alsan Fleece 225 GF

Glass fibre reinforcement mat

Code	Length	Width
115609	20 cm	50 m
115751	100 cm	50 m



Fleece Tape BT

Butyl tape bonded to non-woven fabric

Code	Length	Pack
221537	10x15 cm	8 rolls



Aluband

Self-adhesive butyl sealing tape

Code	Length	Pack
221538	0.6x100 mm x 10 m	6 rolls
221539	0.6x150 mm x 10 m	4 rolls
221010	0.6x75 mm x 10 m	8 rolls
221534	0.6x75 mm x 10 m	8 rolls
221535	0.6x100 mm x 10 m	6 rolls
221536	0.6x150 mm x 10 m	4 rolls



Multiflex

Waterproof band with side supports in polypropylene fabric for joints and reinforcement of junctions between structures.

Code	Length	Width
155009	12 cm	50 m

Liquid Products - Accessories

Filtene

Compactable and anti-adhesive filling element for joints.



Code	Diameter
114156	Ø 10
114566	Ø 20
114567	Ø 30
114157	Ø 40



Draini Alsan straight Alu

Union for rainwater drain for waterproofed roofs/terraces. It is comprised of a special geotextile applied to an aluminium pipe by means of a patented system.

Code	Diameter	Width
119624	Ø 50	400 m
119625	Ø 63	400 m
119626	Ø 75	400 m
119627	Ø 95	400 m



Alsan Macaflash

Tool for applying the reinforcement layer in liquid waterproofing systems

Code		
159074		

Adhesives

Sopravap 3 in 1



Adhesive for the total adherence of various types of insulation panels, which acts as a vapour barrier and does not require use of a primer. SOPRAVAP 3 in 1 is a two-component polyurethane-based liquid resin that works as a primer, vapour barrier and adhesive. Workable for 30 minutes, it completely sets to light foot traffic in 2 hours.

SOPRAVAP 3 in 1 is supplied in 25 kg kits (component A in 20.7 kg can and component B in 4.3 kg can)

Indicative consumption: minimum 2 kg/m² (1.5 mm film after drying and crosslinking), the effective quantity varies depending on the condition of the substrate.

Code	Weight kg	N. Packs/pallet
33947	Comp. A - 20.7 kg	20 kit
33947	Comp. B - 4.3 kg	20 kit

Adhesive for sheets

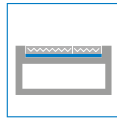

Sopracol Liquid

Cold-applied, ready-to-use adhesive comprised of a solvent-based thixotropic bituminous binder. SOPRACOL LIQUID is specifically designed for bonding in total adhesion of special bitumen membranes produced by Soprema, with a talc-treated, sandblasted, or Texface-coated surface. Compatible substrates: concrete, wood panels, repairs and relaying of pre-existing slated bitumen membranes.

Consumption: 1.0 kg/m² approx.

Code	Weight kg	N. Packs/pallet
33941	25 Kg	30

Adhesive for bitumen membranes

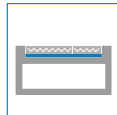

Adhesives

Coltack® Evolution

Single component, solvent-free polyurethane adhesive with controlled expansion for applications on flat roofs. It is mainly used to bond solvent-sensitive and non-sensitive insulation panels on various types of substrates. Damp-proof.

Consumption: 200 / 400 g/m²



Weight kg	Colour	N. Packs/pallet
750 ml	Amber	12 pieces/box
6 Kg	Amber	84

Adhesive for thermoplastic sheets

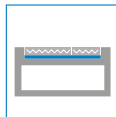

Sopracolle 300 N

Adhesive paste made from bitumen, polymers and solvents, ready-to-use, ideal for the application of non-solvent-sensitive insulation panels.

Consumption: 400 / 600 g/m²



Code	Weight kg	Colour	N. Packs/pallet
30930	25 Kg	Black	30

Adhesive for fibrous sheets

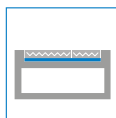

The Soprema range of sealants and foams

Alsan® Mastic 2200

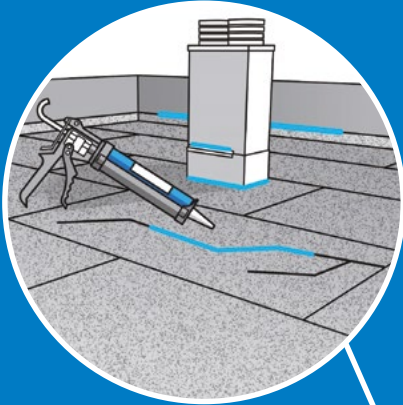

Alsan® Flex 2921 SB



Alsan® Flex 2921 SB

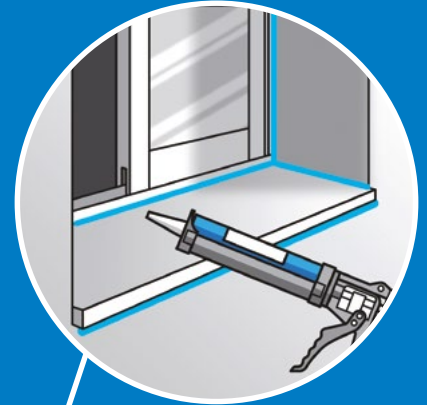

Alsan® Foam EPS/XPS

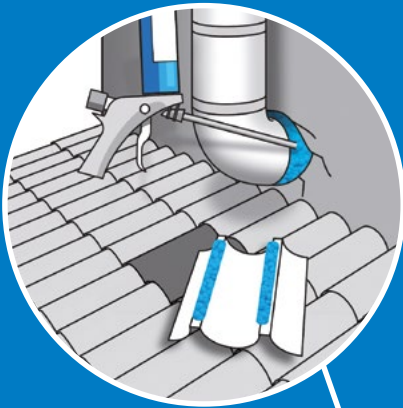

Alsan® Sil 2440 FA

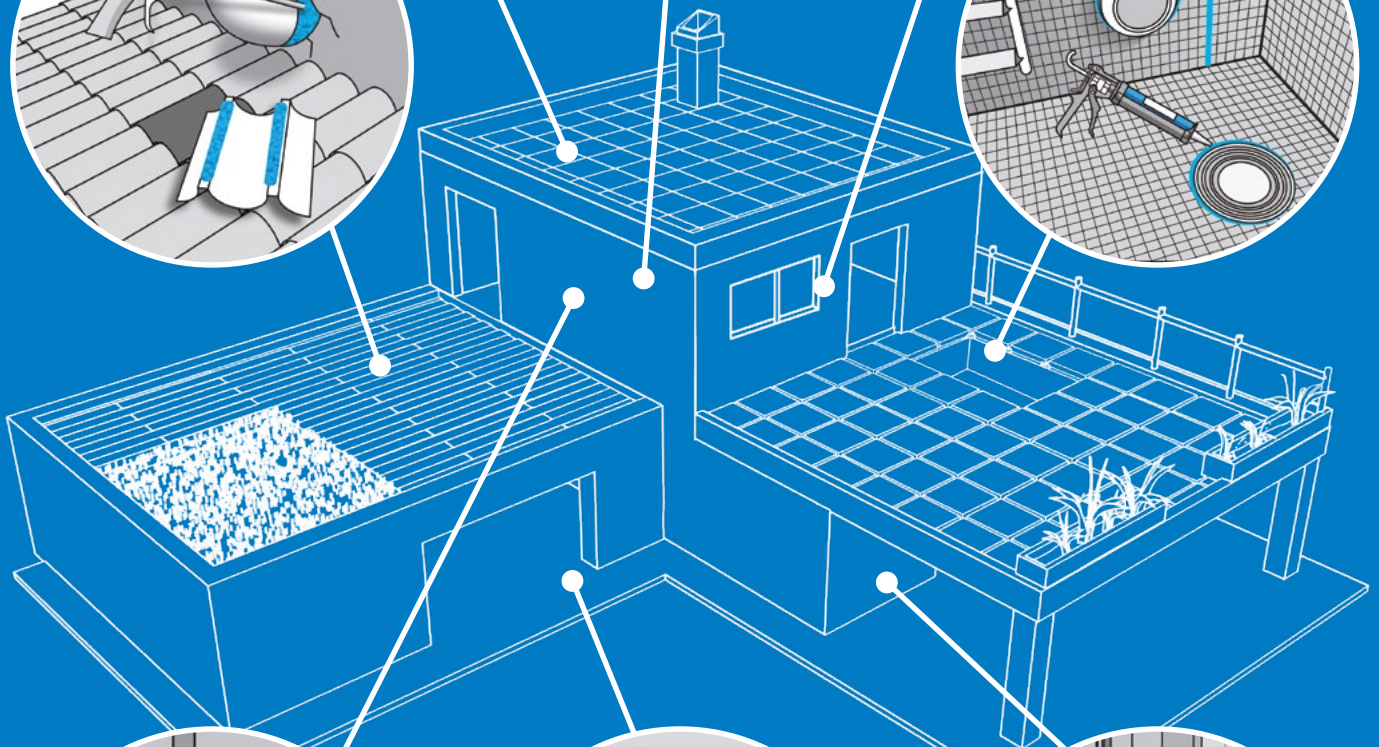
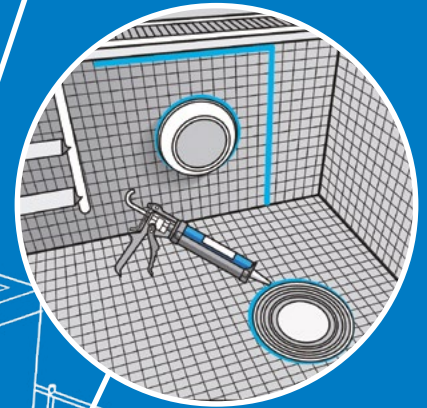

Alsan® Sil 2440 FA

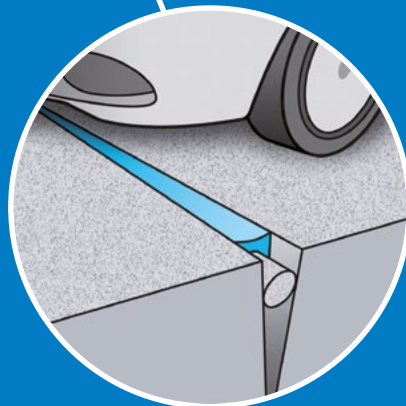

Alsan® Flex 2711 CO



Alsan® Sil 2440 FA

Sealants



Alsan Mastic 2200

Non-crosslinkable sealant made from plasticised synthetic rubber with bitumen. Used in addition to bitumen waterproofing systems as a sealant or joint filler. It is compatible with bituminous products and suitable for outdoor use only.

Code	Pack	Colour	Box
099199	Cartridge (CT) 310 ml	Black	20 CT310

Consumption: as needed



Alsan Flex 2711 CO

Single component, elastic sealant and adhesive. It is a medium modulus polyurethane with excellent adhesion to construction materials. Suitable for both indoor and outdoor applications. Used to seal joints, soundproof pipes and dividing walls. Used as an adhesive to bond tiles, prefabricated elements, etc.

Code	Pack	Colour	Box
152410	Cartridge (CT) 300 ml	White - Grey	12 CT 300
152468	Foil Pack (FP) 600 ml	White - Grey	12 FP 600

Alsan Flex 2711 CO is compliant with:
 EN 15651 part 1:2012: class F-EXT-INT-CC 25LM
 EN 15651 part 4: 2012: PW-EXT-INT-CC
 Classification A + (French VOC regulation)
 LEED requirements. Low-emission materials: adhesives and sealants. SCAQMD 1168 regulation



Alsan Flex 2921 SB

Elastic sealant and single-component adhesive. It is a medium modulus hybrid-based polymer. Suitable for both indoor and outdoor applications. Used with materials such as concrete, bricks, ceramics, glass, wood, galvanised and painted iron sheets.

Code	Pack	Colour	Box
152421	Cartridge (CT) 290 ml	White - Grey	12 CT 300

Alsan Flex 2921 SB is compliant with:
 EN 15651 part 1:2012: F-EXT-INT class 25HM
 EN 15651 part 4:2012: PW-INT
 CE Marking – DoP CCHEU1905



Alsan Sil 2440 FA

Low modulus silicone with neutral polymerisation. It has excellent adhesion to construction materials. It is suitable for both indoor and outdoor applications. Used for the long-lasting sealing of connection and expansion joints; ideal for applications on metal, glass, cement, etc. It can also be used in bathrooms, showers and kitchens.

Code	Pack	Colour	Box
152424	Cartridge (CT) 300 ml	Grey - White - Translucent	12 CT 300

Alsan Sil 2440 FA is compliant with: EN 15651 part 1:2012: F-EXT-INT-CC 25LM
 EN 15651 part 2:2012: G-CC 25LM - EN 15651 part 3:2012: S XS1
 Classification A+ (French VOC regulation) - SNJF class F25E

Foams - Guns



Alsan Foam EPS/XPS

Single component polyurethane adhesive foam. Used to bond thermal insulation panels such as EPS, XPS and PU, cementitious roof shingles and bent tiles. It has excellent adhesion to construction materials. It is suitable for both indoor and outdoor applications.

Code	Pack	Colour	Box
153062	Spray can 750 ml	Light green	12 PC750G

Alsan Foam EPS/XPS is compliant with:
Classification A+ (French VOC regulation) - Reaction to fire class B2 (DIN 4102-3) – E (EN 13501-1)



Alsan Foam UNI

Multipurpose, single component polyurethane foam that provides thermal and acoustic insulation. Used to fix and insulate doors and windows, to seal and grout joints and cavities, insulate electrical sockets and piping. It has excellent adhesion to the most common construction materials. It is suitable for both indoor and outdoor applications.

Code	Pack	Colour	Box
153058	Spray can 750 ml	Yellow	12 PC750G

Alsan Foam UNI is compliant with: Classification A+ (French VOC regulation)



Alsan Foam CL-F

Multipurpose cleaner, used to dissolve non-polymerised or fresh polyurethane foam. Used to clean foam application guns, work tools and surfaces.

Code	Pack	Colour	Box
153065	Spray can 500 ml	Transparent	12 PC500



Foam Gun FG ST5

Application gun for foam, fully coated in PTFE (Teflon). Easy to clean and maintain.

Code	Use	Coating	Length
156182	Foam	PTFE (total)	Standard



Foam Gun FG LG8

Application gun for foam, coated in PTFE (Teflon). The length of the gun allows practical and comfortable application of the foam.

Code	Use	Coating	Length
156183	Foam	PTFE	80 cm



Caulking Gun CG-CT6

Application gun for cartridges in plastic and aluminium.

Code	Use	Coating	Length
156179	Cartridges		Standard



Caulking Gun CG-FP4 / FP6

Gun for 600ml non-rigid cartridges (Foil pack).

Code	Use	Coating	Length
156181	Foil pack		Standard





HEAD OFFICE



Via Industriale dell'Isola, 3 - 24040 Chignolo d'Isola (Bergamo)



Tel. +39.035.095.10.11 | Fax +39.035.494.06.49



info@soprema.it

PRODUCTION PLANTS

Insulating Materials



Verolanuova (Brescia)
San Vito al Tagliamento (Pordenone)
Frigento (Avellino)



info.insulation@soprema.it

Synthetic Membranes



Chignolo d'Isola (Bergamo)
Villa Santo Stefano (Frosinone)



info@soprema.it

Polymer Bitumen Membranes & Waterproofing Liquid Products



Salgareda (Treviso)



novaglass@soprema.it



www.soprema.it

